



Owner's Manual & Operating Instructions



At HM Defense we are dedicated to excellence in engineering, innovation, manufacturing, and customer service. We strive to give our customers the most dependable, rugged, and technologically advanced firearms, parts and silencers available. With multiple patents awarded (Monobloc barrel and HMB bolt) fundamental to the AR design, we are constantly innovating new ways to engineer a more dependable and accurate firearm and a safer, more efficient, and durable silencer. The ability to manufacture nearly all parts inhouse, assures our customers the level of quality that we ourselves hold to a higher standard. In the vast sea of firearms manufacturers, with ever changing customer support centers and lack of customer support, HM Defense is unsurpassed in our personal relationships with our consumers and dealers. When you dial our service number, your call is answered personally by a member of our management team.

All HM firearms, parts and silencers are backed by our 100% parts and service warranty, applicable to all manufacturing defects. We guarantee your satisfaction with our products and services.

From everyone at HM Defense & Technology, we sincerely thank you for your support and appreciate your business.

Clay Barker, CEO

937-444-6500

info@hmdefense.com

www.hmdefense.com

**HM DEFENSE & TECHNOLOGY
OWNER'S MANUAL AND OPERATING INSTRUCTIONS**

TABLE OF CONTENTS

1.	HM DEFENSE'S PRODUCT LINE	
	1A. INTRODUCTION	3
	1B. PATENTED MONOBLOC BARREL	4
	1C. PATENTED HMB BOLT	5-6
	1D. FIREARMS	7-19
	1E. MONOBLOC UPPERS	20-26
	1F. STEALTH INTEGRALLY SUPPRESSED BARREL	27
2.	WARNINGS & PRECAUTIONS	28-29
	2A. COVERTMF5 UPPER & RIFLE WARNING DISCLOSURE	30
	2B. STEALTHMS UPPER, PISTOL & RIFLE WARNING DISCLOSURE	31
3.	PARTS, DESCRIPTIONS & DIAGRAMS	
	3A. COMPLETE LOWER & UPPER RECEIVERS	32
	3B. LOWER RECEIVER AND PARTS	33-34
	3C. UPPER RECEIVER AND PARTS	35
	3D. HMB BOLT CARRIER GROUP (BCG) PARTS	36
4.	SAFETY INSTRUCTIONS	37-40
	RULES FOR SAFE GUN HANDLING	
	OPERATION WARNINGS AND GUIDELINES	
5.	LOADING YOUR HM DEFENSE PISTOL OR RIFLE	41-43
6.	UNLOADING YOUR HM DEFENSE PISTOL OR RIFLE	44-45
7.	STORAGE AND TRANSPORTATION	46
8.	AMMUNITION	47-49
9.	PREPARING TO FIRE	51
10.	FIRING YOUR HM PISTOL OR RIFLE	52-55
11.	FIELD STRIPPING FOR CLEANING	56
12.	CLEANING AND MAINTENANCE	
	12A. FOR UNSUPPRESSED MODELS ONLY-NO STEALTH MODELS	57-59
	12B. FOR SUPPRESSED MODELS-STEALTH SERIES	60-63
13.	REASSEMBLY	64
14.	FUNCTION TEST	65
15.	ACTION OF MECHANISM	66-68
16.	TROUBLE SHOOTING	69
17.	WARRANTY AND DISCLAIMER OF LIABILITY	70

HM DEFENSE & TECHNOLOGY PRODUCT LINE

1A. INTRODUCTION

The HM15 is equipped with a standard safety lever; however, never rely on mechanical safeties as a substitution for safe firearms handling. Be familiar with all functions of your rifle before deploying it.

All HM Defense firearms are engineered to exacting tolerances. This is one reason why it is important to never modify or alter your firearm. Before you use your firearm, you should be fully familiar with its operations. Out of tolerance ammunition will not function properly in your HM rifle, upper or pistol. The use of quality brands of ammunition is highly recommended. We do not recommend steel cased ammunition. Steel cased ammunition can shorten the life of your extractor and can stick to your chamber because steel does not have the same spring back properties as brass.

The HM15 Monobloc barrel, a patented design, eliminates gas block failures. The Monobloc gas block is machined into the barrel as an integral part machined from a single piece of steel stock. There is no longer a need to utilize set screws or pins to affix the gas block to the barrel as seen in all other AR platforms. The need to properly align the gas block or worry about gas block failure has been eliminated. This crucial function of the rifle has been engineered and machined to precise tolerances offering better harmonics, increased accuracy, reliability, smoother function and eliminates gas leakage at the gas block and barrel interface.

Altering any HM Defense firearm, upper or part from its original factory configuration change the legal status and definition of the firearm and will void the warranty. All HM15 pistols are manufactured in accordance with the National Firearms Act and is BATFE compliant as of this writing. Adding a rifle stock or altering the magazine block could result in violation of the National Firearms Act resulting in felonious possession of a short-barreled rifle or an assault rifle in violation of the laws of the states of California, Connecticut, Maryland, Massachusetts, New Jersey, New York and the District of Columbia (at this time) resulting in felonious possession of an assault weapon. (For more information on the National Firearms Act, contact the BATFE).

1B. PATENTED MONOBLOC BARREL

HM MONOBLOC BARREL

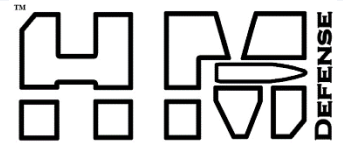

PATENTED

- *Gas block integrally machined as part of barrel*
- *Eliminates gas block installation and alignment*
- *Improved barrel harmonics for better accuracy*
- *Dependable performance in severe conditions*



1. **Barrel:** Available on RaiderMC556, RaiderMC556 SBR, RaiderM556, RaiderM556 SBR, DefenderM556, DefenderM556L, CovertMF5, and Stealth Models. (5.56 NATO/.223 Rem, 300 Blackout and AR10 (308 WIN) models with pistol, carbine or mid-length gas systems. All HM Defense barrels are match grade, tripled honed and button rifled for superior accuracy. Barrels are manufactured in 4150 Chromoly.
2. **Barrel Extension:** All HM barrels feature Mil-Spec M4 feed ramps, properly installed and head spaced with gauges.
3. **Gas Block:** The HM MONOBLOC gas block is machined from the solid barrel blank and is an integral part of the barrel.
4. **Barrel Length** – dependent on model.

Barrel Weights:

- 9.5" Barrel – 1 lb. 4 oz.
- 12.5" Barrel – 1 lb. 10 oz.
- 16" Barrel – 1 lb. 14 oz.



1C. PATENTED HMB BOLT

The Problem with Standard AR Bolts: Existing Mil-Spec M16 and AR15 bolts, as disclosed in military manuals, have a natural weak point where the cam pin hole passes through the bolt. Under extreme use, including competition and combat, current Mil-Spec bolts can fail at this critical location.

The Solution: The HMB Bolt by HM Defense eliminates the pass-through cam pin hole and replaces it with a cam pin socket and radiused cam pin design. This patented design eliminates the natural weak point of Mil-Spec bolts by significantly increasing the amount of steel and strength at the cam pin location.

The HMB Bolt also reduces contact between the cam pin and the firing pin enabling smoother operation of the firing pin, bolt lugs and aft gas rings. The new cam pin socket also retains lubrication for extended operations.

Best of all, the **HMB Bolt is 100% compatible with Mil-Spec M16 & AR-15 bolt carriers and can be installed as a drop-in bolt replacement in any existing M16 or AR15 rifle.**

Materials: Bolt – 9310 steel, Cam pin – 4340 Steel. Finish: Black Nitride.

Note: All bolts must be checked with a go and no go gauge to ensure proper head spacing.

HMB BOLT

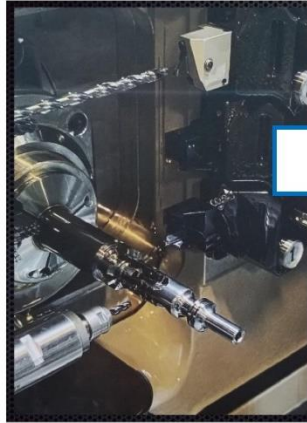

PATENTED

The **HMB Bolt** by HM Defense eliminates the pass through cam pin hole and replaces it with a cam pin socket and tapered cam pin design. This patented design eliminates the natural weak point of Mil-Spec bolts by significantly increasing the amount of metal (and strength) at the cam pin location. The result – ***No more broken bolts!***

Existing Mil-Spec M16 & AR15 bolts have a natural weak point where the cam pin hole passes through the bolt. Under extensive use, including the stress of combat, the bolt can fail at this critical location.

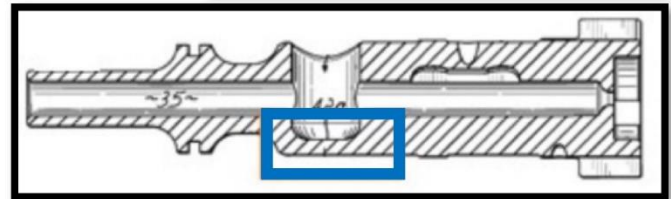
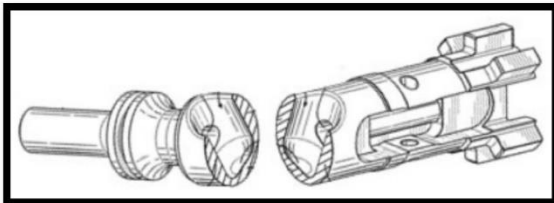
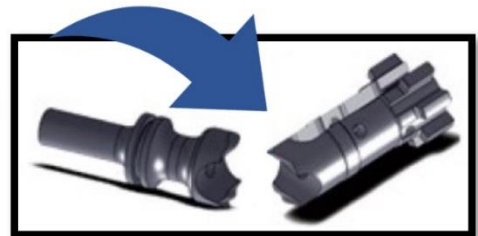

HMB BOLT CUT- AWAY

HMB BOLT CROSS SECTION

Additional benefits of the HMB Bolt design includes the elimination of the cam pin hole staking, reduction in potential cam & firing pin contact and a smoother operation of the Bolt Carrier Group (BCG).

Best of all, the HMB Bolt is 100% compatible with Mil-Spec & AR15 BCGs and can be installed as a drop-in bolt replacement in any existing M16 or AR15 rifle. Available on Guardian F5, RaiderMC556, RaiderMC556 SBR, RaiderM556, RaiderM556 SBR, DefenderM556, DefenderM556L, CovertMF5 and all Stealth models.

www.hmdefense.com

1D. FIREARMS

GUARDIAN *F5*



1. **Barrel:** All HM Defense barrels are match grade, hone and button rifled for superior accuracy. Chambered in 5.56 NATO/.223 Rem, the Guardian F5 4150 chromoly HBAR barrel is 16 inches in length and features a 1:7 twist, mid-length gas barrel. Black cerakote finish.
2. **Rail:** The custom HM Defense 10 3/8", free float 1913 picatinny rail is CNC machined from 6061-T6 aircraft grade aluminum. The rail is compatible with Magpul M-LOK mounting system.
3. **Lower Receiver:** The GuardianF5 features a Mil-Spec forged 7075-T6 lower receiver with Type III Class II hard-coat, black anodized finish.
4. **Upper Receiver:** The GuardianF5 features a Mil-Spec forged 7075-T6 M4 upper receiver with Type III, Class II hard-coat black anodized finish. M4 feed ramps and a 1913 picatinny rail flat top.
5. **Components:** HM Defense rifles include a M16 bolt carrier group with patented HMB Bolt and Mil-Spec components including the trigger and fire control group, charging handle, buffer tube/spring. Custom trigger guard, CNC machine muzzle break and steel standard gas block.
6. **End Plate:** HM Defense rifles and pistols feature a custom quick disconnect (QD) end plate.
7. **Furniture:** Rifle features a black Mil-Spec HM CQB stock and enhanced grip.
8. **Magazine:** A magazine is included with each rifle.
9. **Weight:** 6lb, 11oz without magazine

www.hmdefense.com

DEFENDER M556

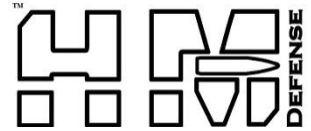

Patented HMB Bolt
Patented Monobloc Barrel

- 1. Barrel:** The DefenderM556 features HM's **patented MONOBLOC HBAR barrel** with an integrally machined gas block. Chambered in 5.56 NATO/.223 Rem, the 4150 chromoly barrel is 16 inches in length, features a 1:8 twist, mid-length gas system. All HM Defense barrels are match grade, honed and button rifled for superior accuracy. Cerakote finish.
- 2. Rail:** The custom HM Defense 10 3/8", free float 1913 picatinny rail is CNC machined from 6061-T6 aircraft grade aluminum. The rail is compatible with Magpul M-LOK mounting system.
- 3. Lower Receiver:** The DefenderM556 features a Mil-Spec forged 7075-T6 lower receiver with Type III Class II hard-coat, black anodized finish.
- 4. Upper Receiver:** The DefenderM556 features a Mil-Spec forged 7075-T6 M4 upper receiver with Type III, Class II hard-coat black anodized finish. M4 feed ramps and a 1913 picatinny rail flat top.
- 5. Components:** HM Defense rifles include a M16 bolt carrier group with **patented HMB Bolt** and Mil-Spec components including the trigger and fire control group, charging handle, buffer tube/spring. Custom trigger guard, Monobloc ejection port cover and CNC machine muzzle break and steel standard gas block.
- 6. End Plate:** HM Defense rifles and pistols feature a custom quick disconnect (QD) end plate.
- 7. Furniture:** Rifle features a black Mil-Spec HM stock and enhanced grip.
- 8. Magazine:** A magazine is included with each rifle.
- 9. Weight:** 6lb, 6.5oz without magazine

www.hmdefense.com

DEFENDER M556L

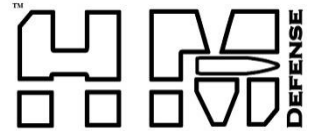

- 1. Barrel:** The DefenderM556L features HM's **patented MONOBLOC HBAR barrel** with an integrally machined gas block. Chambered in 5.56 NATO/.223 Rem, the 4150 chromoly barrel is 16 inches in length, features a 1:8 twist, mid-length gas system. All HM Defense barrels are match grade, honed and button rifled for superior accuracy. Cerakote finish.
- 2. Rail:** The custom HM Defense 15", free float 1913 picatinny rail is CNC machined from 6061-T6 aircraft grade aluminum. The rail is compatible with Magpul M-LOK mounting system.
- 3. Lower Receiver:** The DefenderM556L features a Mil-Spec forged 7075-T6 lower receiver with Type III Class II hard-coat, black anodized finish.
- 4. Upper Receiver:** The DefenderM556L features a Mil-Spec forged 7075-T6 M4 upper receiver with Type III, Class II hard-coat black anodized finish. M4 feed ramps and a 1913 picatinny rail flat top.
- 5. Components:** HM Defense rifles include a M16 bolt carrier group with **patented HMB Bolt** and Mil-Spec components including the trigger and fire control group, charging handle, buffer tube/spring. Custom trigger guard, Monobloc ejection port cover and CNC machine muzzle break and steel standard gas block.
- 6. End Plate:** HM Defense rifles and pistols feature a custom quick disconnect (QD) end plate.
- 7. Furniture:** Rifle features a black Mil-Spec HM stock and enhanced grip.
- 8. Magazine:** A magazine is included with each rifle.
- 9. Weight:** 6lb, 10.5oz without magazine

www.hmdefense.com

COVERT MF5

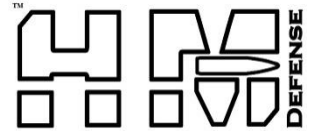

Patented HMB Bolt
Patented Monobloc Barrel

- 1. Barrel:** The CovertMF5 rifle features HM's **patented barrel** with an integrally machined MONOBLOC gas block and flash diverter. Chambered in 5.56 NATO/.223 Rem, the 4150 chromoly barrel is 16.25 OAL (10.75" rifling and 5.5" flash diverter), features a 1:8 twist, mid-length gas system. All HM Defense barrels are match grade, honed and button rifled for superior accuracy. Black cerakote finish.
- 2. Rail:** The custom HM Defense 12", free float 1913 picatinny rail is CNC machined from 6061-T6 aircraft grade aluminum. The rail is compatible with Magpul M-LOK mounting system.
- 3. Lower Receiver:** The CovertMF5 features a Mil-Spec forged 7075-T6 lower receiver with Type III Class II hard-coat, black anodized finish.
- 4. Upper Receiver:** The CovertMF5 features a Mil-Spec forged 7075-T6 M4 upper receiver with Type III, Class II hard-coat black anodized finish. M4 feed ramps and a 1913 picatinny rail flat top.
- 5. Components:** HM Defense rifles include a M16 bolt carrier group with **patented HMB Bolt** and Mil-Spec components including the trigger and fire control group, charging handle and buffer tube/spring. Custom trigger guard, Monobloc ejection port cover.
- 6. End Plate:** HM Defense rifles and pistols feature a custom quick disconnect (QD) end plate.
- 7. Furniture:** Rifle features a black Mil-Spec HM stock and enhanced grip.
- 8. Magazine:** A magazine is included with each rifle.
- 9. Weight:** 6lb, 10oz without magazine

www.hmdefense.com

RAIDER MC556



- 1. Barrel:** The RaiderMC556 pistol features HM's **patented MONOBLOC barrel** with an integrally machined gas block. Chambered in 5.56 NATO/.223 Rem, the 4150 chromoly barrel is 9.5" in length, features a 1:8 twist ratio, 1/2-28 TPI threaded muzzle and a carbine gas system. All HM Defense barrels are match grade, honed and button rifled for superior accuracy. Black cerakote finish.
- 2. Rail:** The custom HM Defense 8.5", free float 1913 picatinny rail is CNC machined from 6061-T6 aircraft grade aluminum. The rail is compatible with Magpul M-LOK mounting system.
- 3. Receiver:** The RaiderMC556 features a Mil-Spec forged 7075-T6 lower receiver with Type III Class II hard-coat, black anodized finish.
- 4. Upper Receiver:** The RaiderMC556 features a Mil-Spec forged 7075-T6 M4 upper receiver with Type III, Class II hard-coat black anodized finish. M4 feed ramps and a 1913 picatinny rail flat top.
- 5. Components:** HM Defense pistols include a M16 bolt carrier group with **patented HMB Bolt** and Mil-Spec components including the trigger and fire control group, charging handle and buffer tube/spring. Custom trigger guard, Monobloc ejection port cover.
- 6. End Plate:** HM Defense rifles and pistols feature a custom quick disconnect (QD) end plate.
- 7. Furniture:** Pistols features a Shockwave 2.0 Blade adjustable pistol stabilizer and enhanced grip.
- 8. Magazine:** A magazine is included with each rifle.
- 9. Weight:** 5lb, 4.5oz without magazine

***For suppressed applications, based on your suppressor, an H2 buffer may be required.

www.hmdefense.com

RAIDER M556

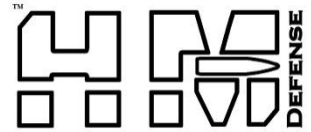

- 1. Barrel:** The RaiderM556 pistol features HM's **patented MONOBLOC barrel** with an integrally machined gas block. Chambered in 5.56 NATO/.223 Rem, the 4150 chromoly barrel is 12.5" in length, features a 1:8 twist ratio, ½-28 TPI threaded muzzle and a mid-length gas system. All HM Defense barrels are match grade, honed and button rifled for superior accuracy. Black cerakote finish.
- 2. Rail:** The custom HM Defense 10 3/8", free float 1913 picatinny rail is CNC machined from 6061-T6 aircraft grade aluminum. The rail is compatible with Magpul M-LOK mounting system.
- 3. Receiver:** The RaiderM556 features a Mil-Spec forged 7075-T6 lower receiver with Type III Class II hard-coat, black anodized finish.
- 4. Upper Receiver:** The RaiderM556 features a Mil-Spec forged 7075-T6 M4 upper receiver with Type III, Class II hard-coat black anodized finish. M4 feed ramps and a 1913 picatinny rail flat top.
- 5. Components:** HM Defense pistols include a M16 bolt carrier group with **patented HMB Bolt** and Mil-Spec components including the trigger and fire control group, charging handle and buffer tube/spring. Custom trigger guard, Monobloc ejection port cover.
- 6. End Plate:** HM Defense rifles and pistols feature a custom quick disconnect (QD) end plate.
- 7. Furniture:** Pistols features a Shockwave 2.0 Blade adjustable pistol stabilizer and enhanced grip.
- 8. Magazine:** A magazine is included with each rifle.
- 9. Weight:** 5lb, 11.5oz without magazine

***For suppressed applications, based on your suppressor an H2 buffer may be required.

www.hmdefense.com

STEALTH MS5



- 1. Barrel:** The StealthMS5 rifle features HM's **patented barrel with an integrally machined MONOBLOC gas block and suppressor**. Chambered in 5.56 NATO/.223 Rem, the 4150 chromoly barrel is 16.25" in OAL (9" of chamber and rifling and 7.25" suppressor), features a 1:8 twist ratio and carbine gas system. All HM Defense barrels are match grade, honed and button rifled for superior accuracy. Black cerakote finish.
- 2. Rail:** The custom HM Defense 10 3/8", free float 1913 picatinny rail is CNC machined from 6061-T6 aircraft grade aluminum. The rail is compatible with Magpul M-LOK mounting system.
- 3. Lower Receiver:** The StealthMS5 features a Mil-Spec forged 7075-T6 lower receiver with Type III Class II hard-coat, black anodized finish.
- 4. Upper Receiver:** The StealthMS5 features a Mil-Spec forged 7075-T6 M4 upper receiver with Type III, Class II hard-coat black anodized finish. M4 feed ramps and a 1913 picatinny rail flat top.
- 5. Components:** HM Defense rifles include a M16 bolt carrier group with **patented HMB Bolt** and Mil-Spec components including the trigger and fire control group, H2 or H3 buffer, red Sprinco spring, charging handle and buffer tube/spring. Custom trigger guard, Monobloc ejection port cover.
- 6. End Plate:** HM Defense rifles and pistols feature a custom quick disconnect (QD) end plate.
- 7. Furniture:** Stealth rifles features a black Mil-Spec HM stock and enhanced grip.
- 8. Magazine:** A magazine is included with each rifle.
- 9. Weight:** 7lb, 14oz without magazine

www.hmdefense.com

STEALTH MS3

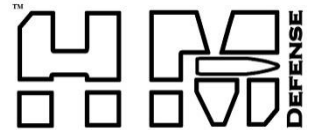

- 1. Barrel:** The StealthMS3 rifle features HM's **patented barrel with an integrally machined MONOBLOC gas block and suppressor**. Chambered in 300 Blackout, the 4150 chromoly barrel is 16.25" in OAL (9" of chamber and rifling and 7.25" suppressor), features a 1:7 twist ratio and pistol length gas system. All HM Defense barrels are match grade, honed and button rifled for superior accuracy. Black cerakote finish.
- 2. Rail:** The custom HM Defense 10 3/8", free float 1913 picatinny rail is CNC machined from 6061-T6 aircraft grade aluminum. The rail is compatible with Magpul M-LOK mounting system.
- 3. Lower Receiver:** The StealthMS5 features a Mil-Spec forged 7075-T6 lower receiver with Type III Class II hard-coat, black anodized finish.
- 4. Upper Receiver:** The StealthMS5 features a Mil-Spec forged 7075-T6 M4 upper receiver with Type III, Class II hard-coat black anodized finish. M4 feed ramps and a 1913 picatinny rail flat top.
- 5. Components:** HM Defense rifles include a M16 bolt carrier group with **patented HMB Bolt** and Mil-Spec components including the trigger and fire control group, H2 or H3 buffer, red Sprinco spring, charging handle and buffer tube/spring. Custom trigger guard, Monobloc ejection port cover.
- 6. End Plate:** HM Defense rifles and pistols feature a custom quick disconnect (QD) end plate.
- 7. Furniture:** Steal rifles features a black Mil-Spec HM stock and enhanced grip.
- 8. Magazine:** A magazine is included with each rifle.
- 9. Weight:** 7lb, 14oz without magazine

www.hmdefense.com

RAIDER M556 SBR



- 1. Barrel:** The RaiderM556 SBR features HM's **patented MONOBLOC barrel** with an integrally machined gas block. Chambered in 5.56 NATO/.223 Rem, the 4150 chromoly barrel is 12.5" in length, features a 1:8 twist ratio, 1/2-28 TPI threaded muzzle and a mid-length gas system. All HM Defense barrels are match grade, honed and button rifled for superior accuracy. Black cerakote finish.
- 2. Rail:** The custom HM Defense 10 3/8", free float 1913 picatinny rail is CNC machined from 6061-T6 aircraft grade aluminum. The rail is compatible with Magpul M-LOK mounting system.
- 3. Lower Receiver:** The RaiderM556 SBR features a Mil-Spec forged 7075-T6 lower receiver with Type III Class II hard-coat, black anodized finish.
- 4. Upper Receiver:** The RaiderM556 SBR features a Mil-Spec forged 7075-T6 M4 upper receiver with Type III, Class II hard-coat black anodized finish. M4 feed ramps and a 1913 picatinny rail flat top.
- 5. Components:** HM Defense SBRs include a M16 bolt carrier group with **patented HMB Bolt** and Mil-Spec components including the trigger and fire control group, charging handle and buffer tube/spring. Custom trigger guard, Monobloc ejection port cover.
- 6. End Plate:** HM Defense rifles and pistols feature a custom quick disconnect (QD) end plate.
- 7. Furniture:** RaiderM556 SBR features an HM Defense adjustable Close Quarter Combat (CQB) stock and enhanced grip.
- 8. Magazine:** A magazine is included with each rifle.
- 9. Weight:** 5lb, 11.5oz without magazine

***For suppressed applications, based on your suppressor an H2 buffer may be required.

www.hmdefense.com

RAIDER MC556 *SBR*



Patented HMB Bolt
Patented Monobloc Barrel

1. **Barrel:** The RaiderMC556 *SBR* pistol features HM’s **patented MONOBLOC barrel** with an integrally machined gas block. Chambered in 5.56 NATO/.223 Rem, the 4150 chromoly barrel is 9.5” in length, features a 1:8 twist ratio, ½-28 TPI threaded muzzle and a carbine gas system. All HM Defense barrels are match grade, honed and button rifled for superior accuracy. Black cerakote finish.
 2. **Rail:** The custom HM Defense 8.5”, free float 1913 picatinny rail is CNC machined from 6061-T6 aircraft grade aluminum. The rail is compatible with Magpul M-LOK mounting system.
 3. **Lower Receiver:** The RaiderMC556 *SBR* features a Mil-Spec forged 7075-T6 lower receiver with Type III Class II hard-coat, black anodized finish.
 4. **Upper Receiver:** The RaiderMC556 *SBR* features a Mil-Spec forged 7075-T6 M4 upper receiver with Type III, Class II hard-coat black anodized finish. M4 feed ramps and a 1913 picatinny rail flat top.
 5. **Components:** HM Defense pistols include a M16 bolt carrier group with **patented HMB Bolt** and Mil-Spec components including the trigger and fire control group, charging handle and buffer tube/spring. Custom trigger guard, Monobloc ejection port cover.
 6. **End Plate:** HM Defense rifles and pistols feature a custom quick disconnect (QD) end plate.
 7. **Furniture:** RaiderMC556 *SBR* features an HM Defense adjustable Close Quarter Combat (CQB) stock and enhanced grip.
 8. **Magazine:** A magazine is included with each rifle.
 9. **Weight:** 5lb, 4.5oz without magazine
- ***For suppressed applications, based on your suppressor, an H2 buffer may be required.

www.hmdefense.com

AVENGERM308

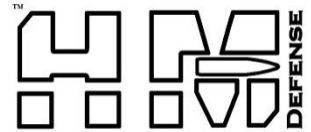

- 1. Barrel:** The AvengerM308 rifle features HM's **patented MONOBLOC barrel with an integrally machined gas block**. Chambered in .308 Win/7.62 NATO, the 4150 chromoly barrel is 18" in length, features a 1:10 twist ratio and a rifle-length gas system. All HM Defense barrels are match grade, honed and button rifled for superior accuracy. Black cerakote finish.
- 2. Rail:** The custom HM Defense 15", free float 1913 picatinny rail is CNC machined from 6061-T6 aircraft grade aluminum. The rail is compatible with Magpul M-LOK mounting system.
- 3. Lower Receiver:** The AvengerM308 features a custom billet lower receiver machined from 7075-T6 and includes unique HM design elements. Cerakote finish.
- 4. Upper Receiver:** The AvengerM308 features a Mil-Spec forged 7075-T6 M4 upper receiver with forward assist. M4 feed ramps and a 1913 picatinny rail flat top. Cerakote finish.
- 5. Components:** AvengerM308 rifles include an AR10 bolt carrier group and charging handle and a 3.5lb enhanced drop in trigger.
- 6. End Plate:** HM Defense rifles and pistols feature a custom quick disconnect (QD) end plate.
- 7. Furniture:** AvengerM308 rifles features a black Mil-Spec HM stock and enhanced grip.
- 8. Magazine:** A 10 round magazine is included with each rifle.
- 9. Weight:** 8lb, 15oz without magazine

www.hmdefense.com

TITAN243

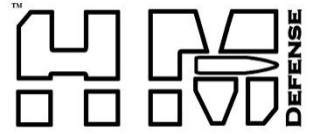

- 1. Barrel:** The Titan243 rifle is chambered in .243 Win, the 4140 chromoly barrel is 20” in length, features a 1:10 twist ratio and a rifle-length gas system (adjustable gas block). All HM Defense barrels are match grade, honed and button rifled for superior accuracy. Black cerakote finish.
- 2. Rail:** The custom HM Defense 14”, free float 1913 picatinny rail is CNC machined from 6061-T6 aircraft grade aluminum. The rail is compatible with Magpul M-LOK mounting system.
- 3. Lower Receiver:** The Titan243 features a custom billet lower receiver machined from 7075-T6 and includes unique HM design elements. Cerakote finish.
- 4. Upper Receiver:** The Titan243 features a Mil-Spec forged 7075-T6 M4 upper receiver with forward assist. M4 feed ramps and a 1913 picatinny rail flat top. Cerakote finish.
- 5. Components:** Titan243 rifles include an AR10 bolt carrier group and extended charging handle and a 3.5lb enhanced drop in trigger.
- 6. End Plate:** HM Defense rifles and pistols feature a custom quick disconnect (QD) end plate.
- 7. Furniture:** Titan243 rifles features a black Mil-Spec HM stock and enhanced grip.
- 8. Magazine:** A 10 round magazine is included with each rifle.
- 9. Weight:** 8lb, 15oz without magazine

www.hmdefense.com

AVENGER6.5

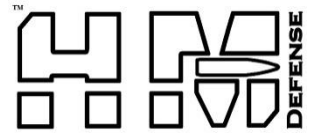

- 1. Barrel:** The Titan243 rifle is chambered in 6.5 Creedmoor, the 4140 chromoly barrel is 20” in length, features a 1:8 twist ratio and a rifle-length gas system (adjustable gas block). All HM Defense barrels are match grade, honed and button rifled for superior accuracy. Black cerakote finish.
- 2. Rail:** The custom HM Defense 14”, free float 1913 picatinny rail is CNC machined from 6061-T6 aircraft grade aluminum. The rail is compatible with Magpul M-LOK mounting system.
- 3. Lower Receiver:** The Avenger6.5 features a custom billet lower receiver machined from 7075-T6 and includes unique HM design elements. Cerakote finish.
- 4. Upper Receiver:** The Avenger6.5 features a Mil-Spec forged 7075-T6 M4 upper receiver with forward assist. M4 feed ramps and a 1913 picatinny rail flat top. Cerakote finish.
- 5. Components:** Avenger6.5 rifles include an AR10 bolt carrier group and extended charging handle and a 3.5lb enhanced drop in trigger.
- 6. End Plate:** HM Defense rifles and pistols feature a custom quick disconnect (QD) end plate.
- 7. Furniture:** Titan243 rifles features a black Mil-Spec HM stock and enhanced grip.
- 8. Magazine:** A 10 round magazine is included with each rifle.
- 9. Weight:** 8lb, 15oz without magazine

www.hmdefense.com

1E. MONOBLOC UPPERS

9.5MBUP **556**



Features

PISTOL UPPER



Patented HMB Bolt Patented Monobloc Barrel

- 1. Barrel:** The HM **MONOBLOC upper** includes an integrally machined **patented** gas block. Chambered in 5.56 NATO/223 Rem, the 4150 Chromoly barrel is 9.5" inches in length, features a 1:8 twist ratio and a carbine gas system. All HM Defense barrels are match grade, triple honed and button rifled for superior accuracy.
- 2. Rail:** The custom HM Defense 8 1/2" inch, free float 1913 Picatinny rail is CNC machined from 6061-T6 aircraft grade aluminum. The rail is compatible with Magpul M-LOK mounting system.
- 3. Upper Receiver:** HM Monobloc upper features a Mil-Spec Forged 7075-T6 M4 Upper Receiver with Type III Class II hard-coat black anodized finish, M4 Feed Ramps, and a 1913 Picatinny rail flat top.
- 4. Components:** HM Defense Monobloc upper includes an M16 bolt carrier group with **patented HMB** bolt and Mil-Spec components and charging handle. Includes dust cover engraved with American flag.
- 5. Muzzle Brake :** HM Defense Monobloc upper includes CNC machined muzzle brake.
- 6. Barrel Finish:** Rifle Black Cerakote finish.
- 7. Weight :** 3lb 7 oz.

HMDefense.com

12.5MBUP 556



Features

PISTOL UPPER



Patented HMB Bolt
Patented Monobloc Barrel

- 1. Barrel:** The HM **MONOBLOC upper** includes an integrally machined **patented** gas block. Chambered in 5.56 NATO/223 Rem, the 4150 Chromoly barrel is 12.5" inches in length, features a 1:8 twist ratio and a mid-length gas system. All HM Defense barrels are match grade, triple honed and button rifled for superior accuracy.
- 2. Rail:** The custom HM Defense 10 3/8" inch, free float 1913 Picatinny rail is CNC machined from 6061-T6 aircraft grade aluminum. It is compatible with Magpul M-LOK mounting system.
- 3. Upper Receiver:** HM Monobloc upper features a Mil-Spec Forged 7075-T6 M4 Upper Receiver with Type III Class II hard-coat black anodized finish, M4 Feed Ramps, and a 1913 Picatinny rail flat top.
- 4. Components:** HM Defense Monobloc upper includes an M16 bolt carrier group with **patented HMB** bolt and Mil-Spec components and charging handle. Includes dust cover engraved with American flag.
- 5. Muzzle Brake :** HM Defense Monobloc upper includes CNC machined muzzle brake.
- 6. Barrel Finish:** Rifle Black Cerakote finish.
- 7. Weight :** 3lb 14 oz

HMDefense.com

16MBUP 556



Features

RIFLE UPPER



Patented HMB Bolt Patented Monobloc Barrel

- 1. Barrel:** The HM **MONOBLOC** upper includes an integrally machined **patented** gas block. Chambered in 5.56 NATO/223 Rem, the 4150 Chromoly barrel is 16 inches in length, features a 1:8 twist ratio and a mid-length gas system. All HM Defense barrels are match grade, tripled honed and button rifled for superior accuracy.
- 2. Rail:** The custom HM Defense 10 3/8 inch, free float 1913 Picatinny rail is CNC machined from 6061-T6 aircraft grade aluminum. The rail is compatible with Magpul M-LOK mounting system.
- 3. Upper Receiver:** HM Monobloc upper features a Mil-Spec Forged 7075-T6 M4 Upper Receiver with Type III Class II hard-coat black anodized finish, M4 Feed Ramps, and a 1913 Picatinny rail flat top.
- 4. Components:** HM Defense Monobloc upper includes an M16 bolt carrier group with **patented HMB** bolt and Mil-Spec components and charging handle. Includes dust cover engraved with American flag.
- 5. Muzzle Brake :** HM Defense Monobloc upper includes CNC machined muzzle brake.
- 6. Barrel Finish:** Rifle Black Cerakote finish.
- 7. Weight :** 4lb 3 oz

HMDefense.com

16MBUP 556-L

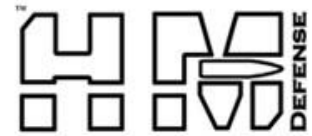

Features

RIFLE UPPER

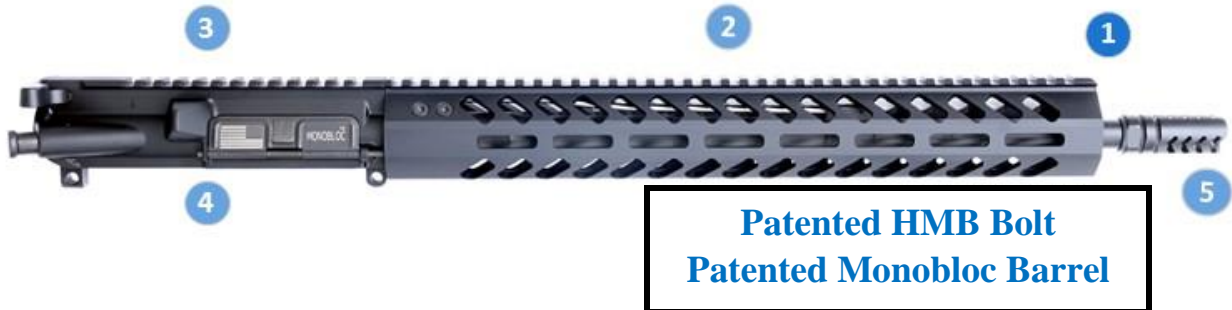

1. **Barrel:** The HM **MONOBLOC** upper includes an integrally machined **patented** gas block. Chambered in 5.56 NATO/223 Rem, the 4150 Chromoly barrel is 16 inches in length, features a 1:8 twist ratio and a mid-length gas system. All HM Defense barrels are match grade, triple honed and button rifled for superior accuracy.
2. **Rail:** The custom HM Defense 15 inch, free float 1913 Picatinny rail is CNC machined from 6061-T6 aircraft grade aluminum. The rail is compatible with Magpul M-LOK mounting system.
3. **Upper Receiver:** HM Monobloc upper features a Mil-Spec Forged 7075-T6 M4 Upper Receiver with Type III Class II hard-coat black anodized finish, M4 Feed Ramps, and a 1913 Picatinny rail flat top.
4. **Components:** HM Defense Monobloc upper includes an M16 bolt carrier group with **patented HMB** bolt and Mil-Spec components and charging handle. Includes dust cover engraved with American flag.
5. **Muzzle Brake :** HM Defense Monobloc upper includes CNC machined muzzle brake.
6. **Barrel Finish:** Rifle Black Cerakote finish.
7. **Weight :** 4lb 6 oz

HMDdefense.com

16MFUP 556



RIFLE UPPER

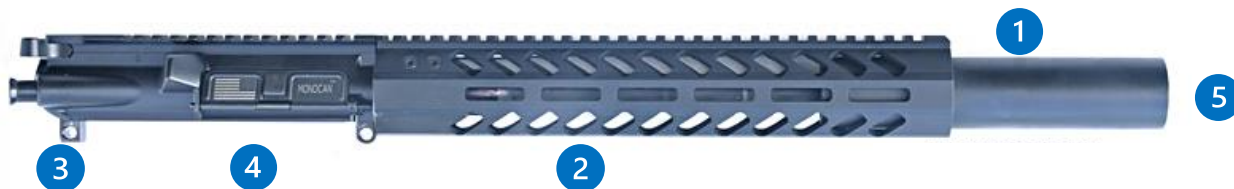

Patented HMB Bolt
Patented Monobloc Barrel

1. **Barrel:** The HM MonoFlash upper features HM's integrally machined, patented gas block. Chambered in 5.56 NATO/.223 Rem, the 4150 chromoly barrel is 16" OAL length with 10.75" chamber and rifling and 5.5" flash and sound diverter. Features a 1:8 twist ratio and mid-length gas system. All HM Defense barrels are match grade, honed and button rifled for superior accuracy.
2. **Rail:** The custom HM Defense 12", free float 1913 picatinny rail is CNC machined from 6061-T6 aircraft grade aluminum. The rail is compatible with Magpul M-LOK mounting system.
3. **Upper Receiver:** HM Monobloc upper features a Mil-Spec forged 7075-T6 M4 upper receiver with Type III, Class II hard-coat black anodized finish. M4 feed ramps and a 1913 picatinny rail flat top.
4. **Components:** HM Defense Monobloc upper includes a M16 bolt carrier group with **patented HMB Bolt** and Mil-Spec components and charging handle. Includes American Flag ejection port cover.
5. **Barrel Finish:** Black Cerakote finish.
6. **Weight:** 4lb

www.hmdefense.com

STEALTH556 *SUPPRESSOR UPPER*



HMDefense.com

Worlds First Truly Integrally Suppressed AR15 Rifle Upper



5.56 NATO / 223 Rem NFA ITEM

“The look everybody is after !!!”

Features

- 1. Barrel:** The Stealth Suppressor rifle upper features HM **patented** barrel with an integrally machined MONOBLOC gas block and integral **suppressor**. Chambered in 5.56 NATO/223 Rem, the 4150 Chromoly barrel is 16.25 inches OAL (9” barrel with 7.25” integral suppressor), features a 1:8 twist ratio and a carbine-length gas system. All HM Defense barrels are match grade and button rifled for superior accuracy. Black high temperature CERAKOTE finish. No SBR Permit required. NFA rules apply to suppressor.
- 2. Rail:** The custom HM Defense 10-3/8 inch, free float 1913 Picatinny rail is CNC machined from 6061-T6 aircraft grade aluminum. The rail is compatible with Magpul M-LOK mounting system.
- 3. Upper Receiver:** Stealth Suppressor rifle upper features a Mil-Spec Forged 7075-T6 M4 Upper Receiver with Type III Class II hard-coat black anodized finish, M4 Feed Ramps, and a 1913 Picatinny rail flat top.
- 4. Components:** HM Defense rifles include a M16 bolt carrier group with **patented HMB** bolt and Mil-Spec components, enhanced charging handle and Monobloc Dust Cover.
- 5. Weight :** 5lb 8oz

STEALTH300 *SUPPRESSOR UPPER*



Worlds First Truly Integrally Suppressed AR15 Rifle Upper

HMDefense.com



300 Blackout NFA ITEM

"The look everybody is after !!!"

Features

- 1. Barrel:** The Stealth300 Suppressor rifle upper features HM **patented** barrel with an integrally machined MONOBLOC gas block and integral **suppressor**. Chambered in 300 Blackout, the 4150 Chromoly barrel is 16.25 inches OAL (9" barrel with 7.25" integral suppressor), features a 1:7 twist ratio and pistol length gas system. All HM Defense barrels are match grade and button rifled for superior accuracy. Black high temperature CERAKOTE finish. No SBR Permit required. NFA rules apply to suppressor.
- 2. Rail:** The custom HM Defense 10-3/8 inch, free float 1913 Picatinny rail is CNC machined from 6061-T6 aircraft grade aluminum. The rail is compatible with Magpul M-LOK mounting system.
- 3. Upper Receiver:** Stealth300 Suppressor rifle upper features a Mil-Spec Forged 7075-T6 M4 Upper Receiver with Type III Class II hard-coat black anodized finish, M4 Feed Ramps, and a 1913 Picatinny rail flat top.
- 4. Components:** HM Defense rifles include a M16 bolt carrier group with **patented HMB** bolt and Mil-Spec components, enhanced charging handle and Monobloc Dust Cover.
- 5. Weight :** 5lb 8oz

1F. STEALTH INTEGRALLY SUPPRESSED BARREL

STEALTH *Integral Suppressor*



THE WORLD'S FIRST TRULY INTEGRALLY SUPPRESSED AR15 BARREL

- Patented barrel with integrally machined gas block and suppressor
 - OAL length is 16.25", No SBR permit required
 - Eliminates gas block installation and alignment
 - Improved barrel harmonics for better accuracy
 - Dependable performance in severe conditions
 - No welding, pinning or joining methods required
 - No muzzle adaptors to purchase or install
 - No suppressor back off, no baffle strikes!
 - Compact OAL rifle compared to traditional designs
7. **Barrel:** Chambered in 5.56 NATO/.223 Rem with a carbine gas system. The 1:8 twist ratio, 4150 chromoly barrel is 16.25" OAL length. Chamber and rifling equals 9" with integrally machined gas block and 7.25" suppressor. NO NFA SBR permit required. All HM Defense barrels are match grade, honed and button rifled for superior accuracy.
 8. **Barrel extension:** All HM barrels feature Mil-Spec M4 feed ramps, properly installed and head spaced with go and no-go gauges.
 9. **Gas Block:** The HM Monobloc gas block is machined from the solid barrel blank and is an integral part of the barrel.
 10. **Baffles:** Baffles are machined from 17-4 PH stainless steel and are heat treated to H900.
 11. **Barrel Finish:** Black, high heat, cerakote finish.

www.hmdefense.com

2. WARNINGS & PRECAUTIONS

WARNING

ALL HM DEFENSE FIREARMS ARE SEMI-AUTOMATIC FIREARMS CAPABLE OF FIRING WITHOUT A MAGAZINE. DO NOT ATTEMPT TO LOAD, OPERATE OR FIRE YOUR HM15 BEFORE READING AND UNDERSTANDING THE SAFETY INFORMATION IN THIS MANUAL. KEEP ALL FIREARMS IN A SAFE LOCATION AND AWAY FROM CHILDREN. HM DEFENSE RECOMMENDS THAT CHILDREN BE EDUCATED ON SAFE FIREARM HANDLING PRACTICES. THE N.R.A. PROVIDES CHILD EDUCATION IN AN INFORMATIVE AND FUN MANNER FOR CHILDREN.

TREAT YOUR HM15, AND ALL FIREARMS, AS THEY ARE LOADED AT ALL TIMES.
WHEN SHOOTING YOUR HM15, BE AWARE OF THE SURROUNDINGS AND WHAT IS BEHIND YOUR TARGET.



IMPORTANT: HM DEFENSE & TECHNOLOGY PRODUCTS ARE **POTENTIALLY LETHAL!** OUR PRODUCTS ARE CLASSIFIED AS FIREARMS, SILENCERS OR DANGEROUS WEAPONS BY THE BUREAU OF ALCOHOL, TOBACCO, FIREARMS AND EXPLOSIVES.



IMPORTANT: READ AND UNDERSTAND THE ENTIRE OWNER'S MANUAL AND OPERATING INSTRUCTIONS BEFORE REMOVING THE FIREARM FROM ITS BOX. YOUR SAFETY AND THE SAFETY OF OTHERS DEPENDS ON YOU FOLLOWING THE INSTRUCTIONS ON PROPER HANDLING AND FUNCTIONING OF YOUR HM15 FIREARM.



WARNING: CARELESS OR IMPROPER HANDLING CAN RESULT IN UNINTENTIONAL DISCHARGE AND COULD RESULT IN PROPERTY DAMAGE, SERIOUS INJURY OR DEATH.



NOTICE: ALL HM FIREARMS AND SILENCERS ARE CAREFULLY TESTED AND INSPECTED AT EVERY STAGE OF THE MANUFACTURING, ASSEMBLY AND TEST FIRING PROCESS. HM DEFENSE CANNOT CONTROL THE PRODUCTS AFTER THEY LEAVE THE FACTORY. THEREFORE, PLEASE CAREFULLY INSPECT YOUR PRODUCT AT THE TIME OF PURCHASE TO INSURE IT IS UNLOADED AND UNDAMAGED.



DISCLAIMER: HM DEFENSE AND TECHNOLOGY SHALL NOT BE RESPONSIBLE FOR ANY DAMAGE, INJURY OR DEATH RESULTING FROM ANY INTENTIONAL, UNINTENTIONAL OR ACCIDENTAL DISCHARGE OF THE FIREARM, OR FROM ANY FIREARM OR SILENCER FUNCTION WHEN USED FOR ANY IMPROPER PURPOSE FOR WHICH IT WAS NOT DESIGNED. HM DEFENSE WILL NOT HONOR ANY CLAIMS INVOLVING THE FIREARM OR SILENCER WHICH RESULTED FROM CARELESS OR IMPROPER HANDLING, UNAUTHORIZED USE AND/OR MODIFICATION, ADJUSTMENT OR UNAUTHORIZED PART(S), REPLACEMENT, CORROSION, NEGLIGENCE, IMPROPER CLEANING, IMPROPER CALIBER AMMUNITION OR THE USE OF AMMUNITION OTHER THAN ORIGINAL, COMMERCIALY AVAILABLE, HIGH-GRADE AMMUNITION IN GOOD CONDITION, OR ANY COMBINATION THEREOF. HM DEFENSE WILL NOT HONOR ANY SUCH CLAIMS INVOLVING FIREARMS OR SILENCERS, FOR ANY REASON OR CAUSE, WHEN CLAIMS ARE MADE BY THE SECOND OR SUBSEQUENT OWNER.



IMPORTANT: ALWAYS BE AWARE AND COMPLY WITH ALL RELEVANT FEDERAL AND LOCAL FIREARMS/SILENCER REGULATIONS GOVERNING THE FIREARM/SILENCER PROPER POSSESSION AND USE. IF UNFAMILIAR WITH FIREARMS, SEEK FURTHER EDUCATION THROUGH SAFE-HANDLING COURSES FACILITATED BY ACCREDITED LOCAL GUN CLUBS, NRA APPROVED INSTRUCTORS OR SIMILAR QUALIFIED ORGANIZATION.

2A. COVERT UPPER AND RIFLE WARNING DISCLOSURE

SAFETY DISCLOSURE FORM

CovertMF5 Rifle Models

CovertMF5 Complete Upper Models



IMPORTANT READ INSTRUCTIONS CAREFULLY

Covert models have a muzzle blast diverter, sending sound and muzzle blast down range away from the shooter and bystanders.

- The muzzle cap is installed with Loctite so that it will not back off.
- Do not try to remove the muzzle cap or you can damage the barrel.
- When cleaning the barrel use a bore brush followed by a bore mop. Do not use a jag and patch or the cleaning patch can fall into the muzzle diverter and removal will be difficult.
- Do not fire/shoot the rifle with any debris or liquids in the diverter.

*Failure to follow these instructions can damage the barrel and will **void the warranty.***

2B. STEALTHMS UPPER, PISTOL & RIFLE WARNING DISCLOSURE



StealthMS5 Rifle Models, StealthMS3 Rifle Models

StealthMS3P Pistol Models, StealthMS3PSBR Pistol Models

StealthMS5, StealthMS3, StealthMS3P Complete Upper Models

*For Stealth556 (5.56) Uppers, we recommend an H3 buffer and red SPINCO spring.

*For Stealth300 (300 BLK) Uppers, we recommend a standard buffer and spring.



***IMPORTANT: READ INSTRUCTIONS CAREFULLY
BEFORE FIRING THE RIFLE OR UPPER***

StealthMS5 models are integrally suppressed weapons that have a maintenance free silencer.

1. The silencer cap is installed with Loctite so that it will not back off.
2. Do not try to remove the silencer cap or you can damage the barrel and silencer. If silencer service is required, it will be performed by an HM factory technician.
3. When cleaning the barrel, use a nylon bore brush followed by a bore mop. Do not use a jag and patch or the cleaning patch can fall into the silencer and removal will be difficult. Do not use a bore snake or it can get caught in the silencer baffles.
4. Do not fire the rifle or upper with any debris or liquids in the silencer. The bore and silencer must be clear of all debris prior to firing the weapon.

****Failure to follow these instructions can be dangerous, can damage the silencer and will void the warranty.**

3. PARTS, DESCRIPTIONS AND DIAGRAMS
3A. AR RECEIVERS



COMPLETE LOWER RECEIVER
COMPLETE UPPER RECEIVERS

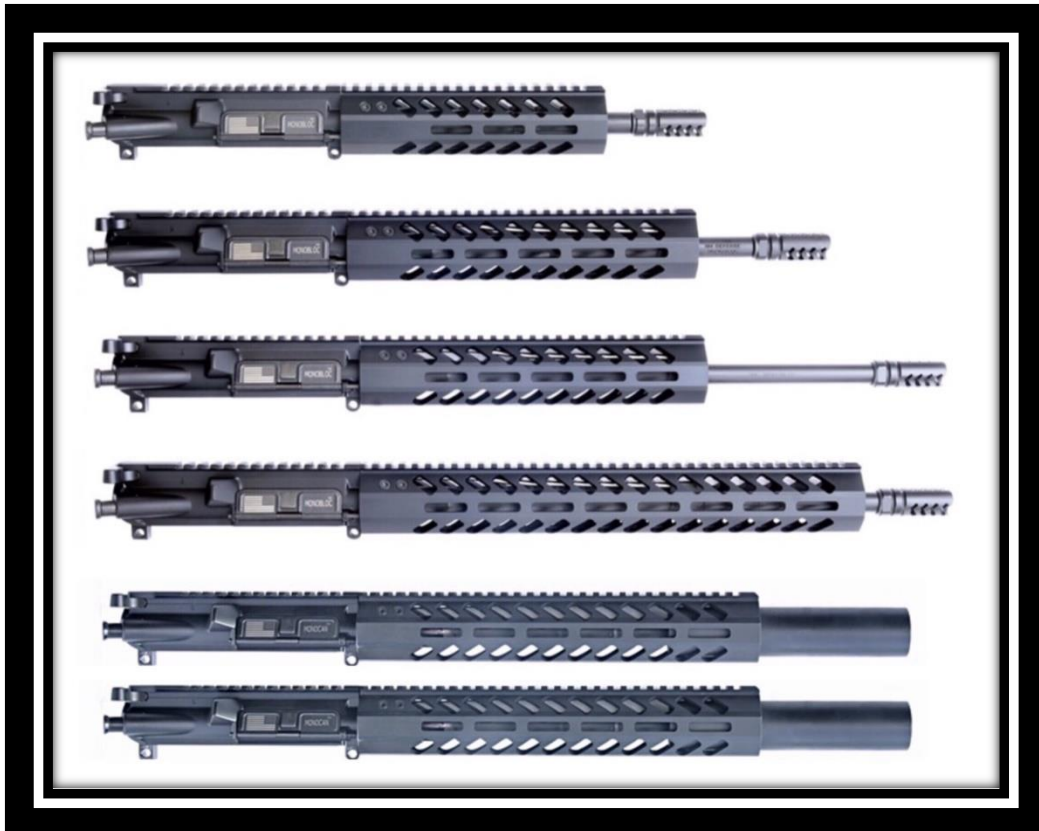

3B. LOWER RECEIVER WITH PARTS (RIGHT SIDE)

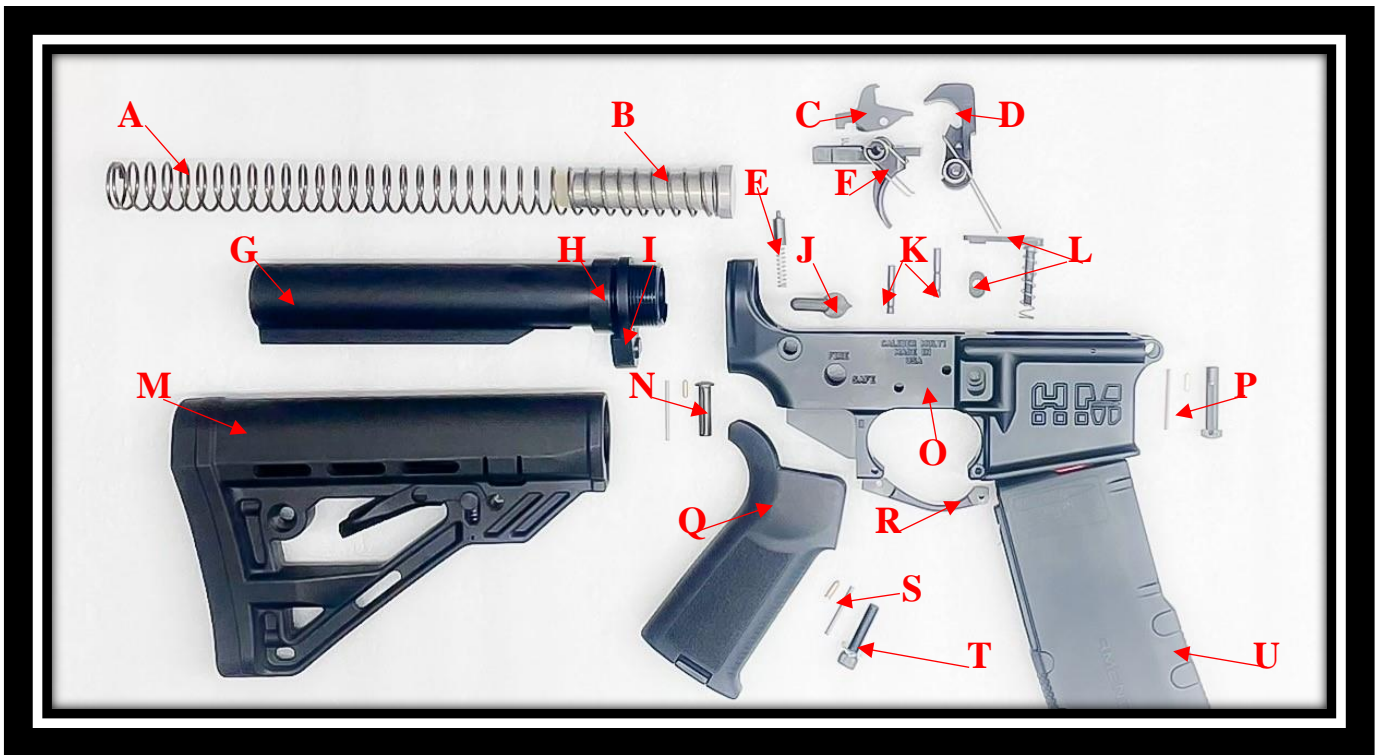

INDEX:

- A = BUFFER SPRING
- B = BUFFER
- C = DISCONNECTOR, SEMI-AUTO
- D = HAMMER ASSEMBLY, SEMI-AUTO (HAMMER & HAMMER SPRING)
- E = BUFFER RETAINING SPRING & PIN
- F = TRIGGER ASSEMBLY, SEMI-AUTO (TRIGGER, TRIGGER SPRING AND DISCONNECTOR SPRING)
- G = BUFFER TUBE
- H = CASTLE NUT
- I = REAR RECEIVER END PLATE WITH QD SWIVEL ATTACHMENT
- J = SELECTOR LEVER (SAFETY)
- K = TRIGGER, HAMMER PINS (X2)
- L = MAGAZINE CATCH, MAGAZINE CATCH SPRING, MAGAZINE RELEASE BUTTON
- M = BUTTSTOCK FOUND ON RIFLE MODELS. BLADES ON PISTOL MODELS
- N = REAR TAKEDOWN PIN ASSEMBLY – TAKEDOWN PIN, SPRING & DETENT
- O = LOWER RECEIVER
- P = FRONT, PIVOT TAKEDOWN PIN ASSEMBLY – TAKEDOWN PIN, SPRING & DETENT
- Q = PISTOL GRIP WITH PISTOL GRIP CAP
- R = TRIGGER GUARD
- S = SAFETY SELECTOR DETENT AND SPRING
- T = LOCK WASHER AND SCREW FOR PISTOL GRIP
- U = MAGAZINE

3B. LOWER PARTS RECEIVER WITH PARTS (LEFT SIDE)

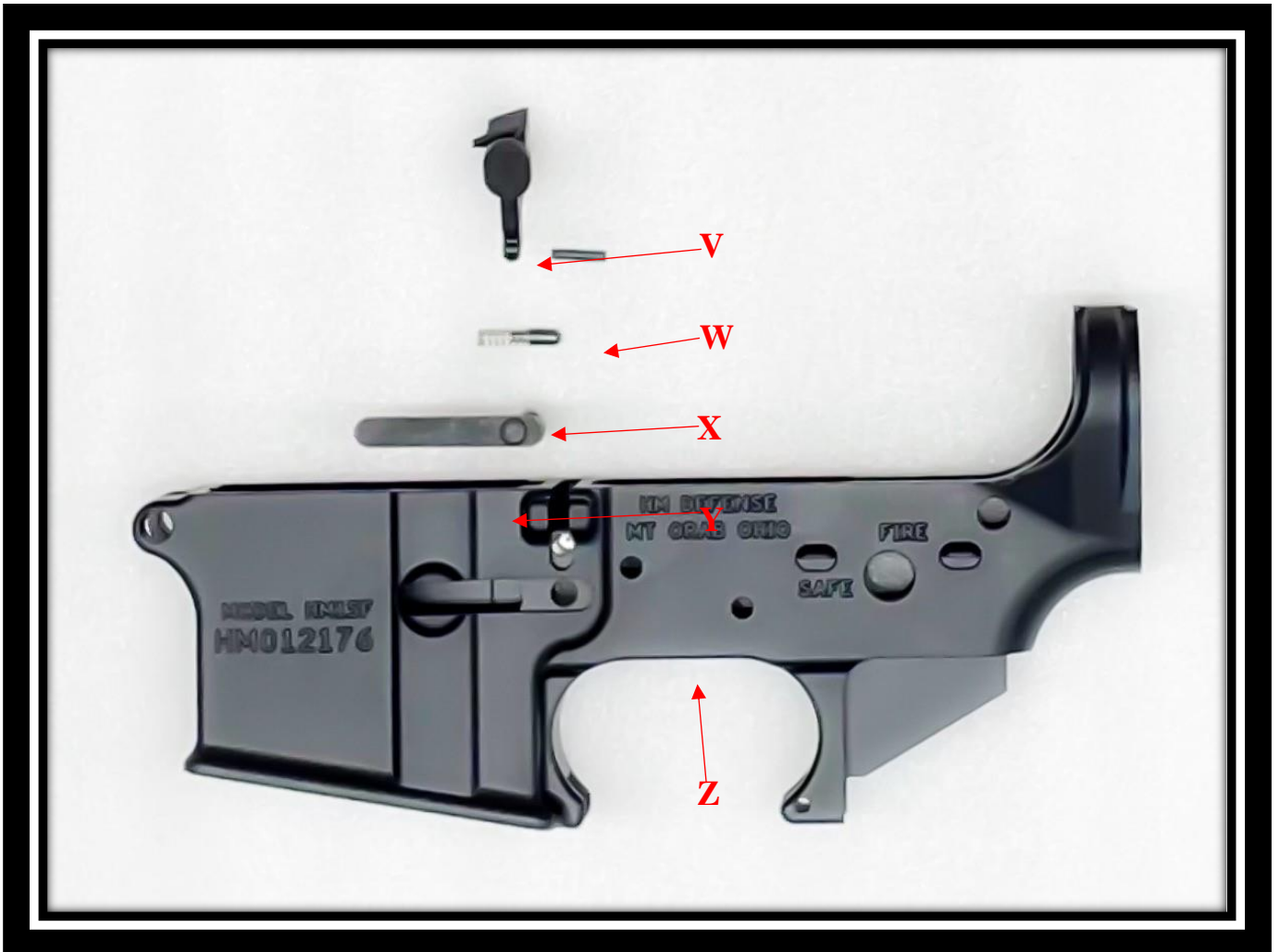

INDEX:

V = BOLT CATCH

W = BOLT CATCH PIN

X = BOLT CATCH SPRING & PLUNGER

Y = MAGAZINE CATCH

Z = LOWER RECEIVER

3C. UPPER RECEIVERS AND PARTS

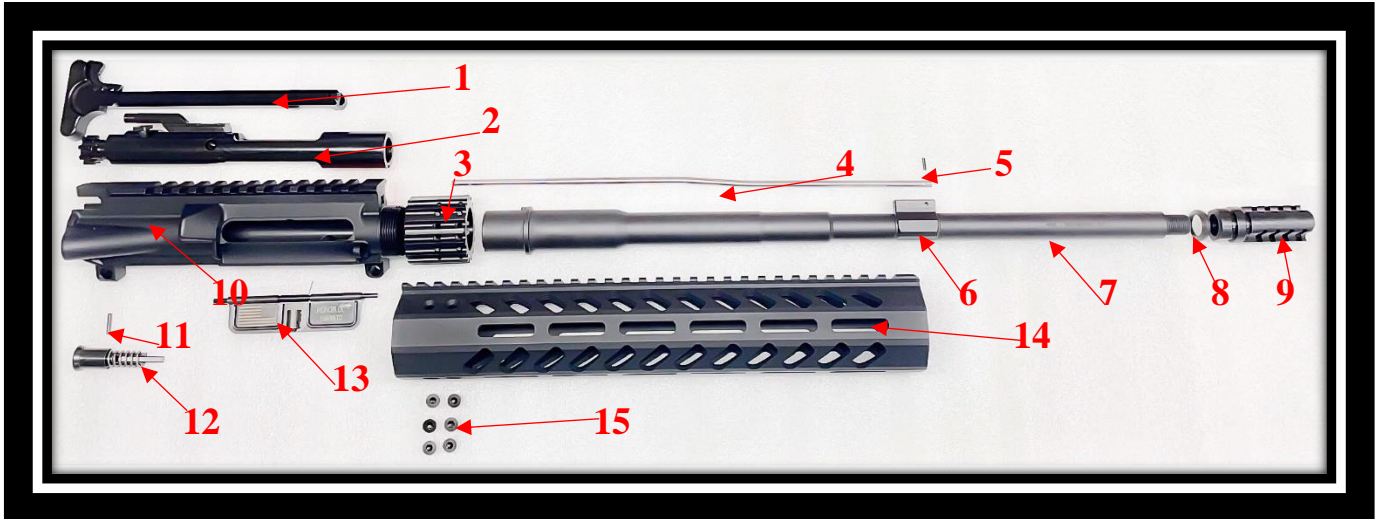

INDEX:

- 1 = CHARGING HANDLE
- 2 = COMPLETE BOLT CARRIER GROUP (BCG) WITH HMB BOLT
- 3 = BARREL NUT
- 4 = GAS TUBE
- 5 = GAS TUBE PIN
- 6 = INTEGRAL GAS BLOCK (MONOBLOC)
- 7 = MONOBLOC BARREL
- 8 = CRUSH WASHER
- 9 = MUZZLE BREAK/FLASH HIDER
- 10 = UPPER RECEIVER
- 11 = FORWARD ASSIST PIN
- 12 = FORWARD ASSIST AND SPRING
- 13 = EJECTION PORT COVER, EJECTION PORT COVER BAR, SPRING & E-CLIP
- 14 = HANDGUARD/RAIL
- 15 = RAIL SCREWS (X6)

3D. HMB BOLT CARRIER GROUP (BCG) PARTS

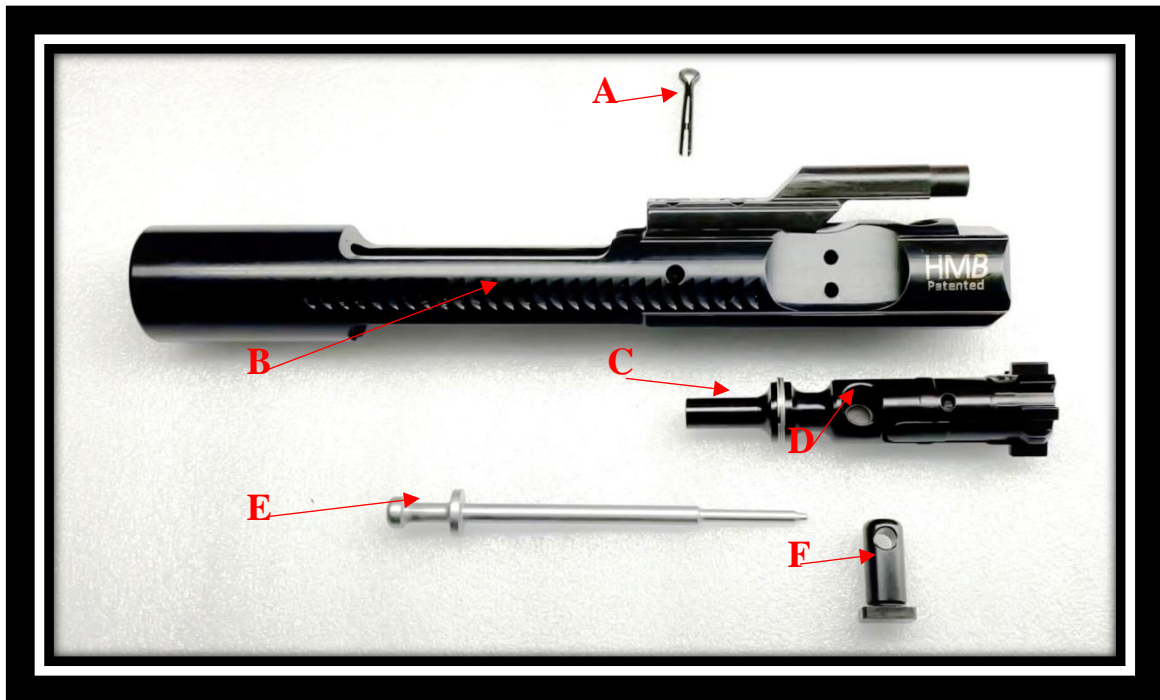

INDEX:

- A = COTTER PIN (FIRING PIN RETAINING PIN)
- B = CARRIER
- C = PATENTED HMB BOLT
- D = PATENTED RADIUS CAM PIN SOCKET
- E = FIRING PIN
- F = RADIUS CAM PIN

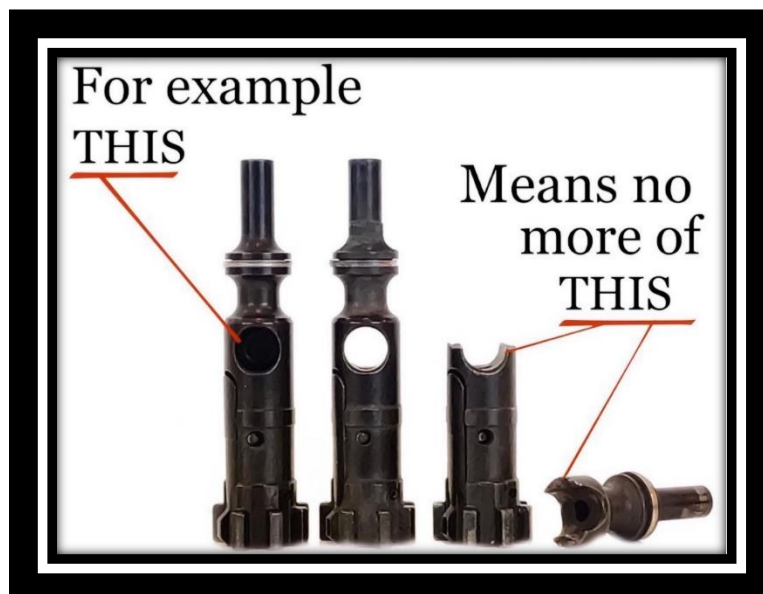

4. SAFETY INSTUCTIONS

TO SAFELY AND PROPERLY HANDLE YOUR FIREARM OR SILENCER, YOU MUST UNDERSTAND THAT DAMAGE TO PROPERTY, INJURY OR DEATH TO YOU OR OTHERS MAY RESULT FROM UNSAFE OR CARELESS USE.

Keep in mind that while the general rules of safe gun handling always apply, circumstances or conditions may exist that require additional precautions to be taken.

- Always keep the muzzle pointed in a safe direction
- Treat every gun as if it were loaded
- Never leave your firearm unattended or unsecured. Someone, including a child, may pick up and cause damage, injury and death with your firearm.
- **YOU ARE RESPONSIBLE FOR YOUR FIREARM!**
- Never allow your firearm or silencer to be used by anyone who has not read and understood this owner's manual.
- Always remove the magazine and lock the bolt to the rear before laying down or handing someone a firearm.
- Load your firearm only when ready to fire the weapon
- Keep the safety on until ready to fire
- Keep your finger off and away from the trigger until you are going to shoot the weapon
- Move the safety from "Safe" to "Fire" only when ready to shoot
- Fire the weapon only when you are sure of your target and backstop
- Do not fire the weapon if unsure where the bullet will travel if the backstop is penetrated
- Never shoot at or near rocks, hard surfaces, water or any other area which may cause a ricochet or make your bullet go off course and cause damage, injury or death.
- Never rely on a mechanical safety as a replacement or substitute for safe gun handling procedures.
- Even if you have handled and or fired an auto loading firearm before; practice inserting and removing an empty magazine to become accustomed to the weapon handling characteristics
- Always keep the barrel free of obstructions, dirt, mud, sand and other debris

- **CAUTION: Silencers can reach extremely high temperatures during and after the firearm is shot. DO NOT TOUCH THE SILENCER or place the silencer on any type of material that may combust, catch fire or melt.**
- If you suspect that the barrel of the firearm may be obstructed, unload the firearm, examine the bore and remove any obstruction and clean before reloading and firing the weapon. An obstructed barrel may burst, destroying the firearm and seriously injuring the shooter or bystanders
- When moving over, under or on any obstacle, always maintain control of the muzzle direction. Unload the firearm if there is any chance that you might fall and or lose control of the muzzle direction
- To avoid an accidental discharge, always keep the chamber empty until ready to fire
- Guns, alcohol or drugs DO NOT MIX. Shooting impaired may cause serious injury or death to the shooter or others.

RULES FOR SAFE GUN HANDLING

- **THE FIREARM IS UNLOADED ONLY WHEN THE MAGAZINE IS REMOVED AND THE CHAMBER IS EMPTY. TREAT EVERY FIREARM AS IF IT IS LOADED**
- When handing or transferring a firearm to another person or accepting a firearm from another person, ALWAYS inspect the firearm; open the action and inspect the chamber to verify that the firearm is unloaded. EVERY TIME!
- Always point the gun in a safe direction when loading and unloading the firearm.
- Always unload your firearm before cleaning
- Always wear eye and ear protection when using a firearm
- Discharging a firearm in a building, home or apartment always causes property damage, injury and/or death. Centerfire bullets can penetrate several floors and/or walls and strike an unintended target causing death.
- ALWAYS WEAR EYE AND EAR PROTECTORS THAT ARE SPECIFIED FOR FIREARM USE EVERY TIME YOU DISCHARGE YOUR FIREARM. Make sure others in the vicinity of where you will be shooting do so as well
- ALWAYS USE THE CORRECT AMMUNITION FOR YOUR PARTICULAR FIREARM AS INDICATED BY THE MARKING ON THE FIREARM NEVER USE NON-STANDARD, RELOADED OR “HAND-LOADED” AMMUNITION AS IT MAY CAUSE DAMAGE TO YOUR RIFLE AND IT WILL VOID YOUR WARRANTY

- **NEVER DISASSEMBLE YOUR FIREARM BEYOND THE FIELD STRIPPING PROCEDURE OUTLINED IN THIS MANUAL.** Improper disassembly or reassembly of your firearm may be dangerous and can lead to serious injury or death
- **NEVER MANIPULATE, ADJUST OR CHANGE ANY OF THE INTERNAL COMPONENTS OF YOUR FIREARM.** Improper manipulation of any internal component may affect the safety and reliability of your firearm and may cause serious injury or death
- **NEVER ALLOW ANY ALTERATION OR REPLACEMENT OF PARTS IN YOUR HM15 UNLESS PERFORMED BY A QUALIFIED GUNSMITH.** If you do, improper functioning of your firearm may occur and serious injury or death may result.
- **HM DEFENSE & TECHNOLOGY WILL NOT BE RESPONSIBLE FOR ANY PERSONAL INJURY, DEATH OR PROPERTY DAMAGE THAT RESULTS FROM: (1) THE CRIMINAL OR NEGLIGENT USE OF THIS FIREARM; (2) A DISREGARD OF THESE SAFETY INSTRUCTIONS AND WARNINGS; (3) IMPROPER OR CARELESS HANDLING OF THIS FIREARM; (4) THE USE OF A NON-STANDARD, DEFECTIVE, IMPROPER OR RELOADED AMMUNITION; AND (5) IMPROPER OR NEGLIGENT MODIFICATIONS OR REPAIRS TO THE FIREARM.**

OPERATION WARNINGS AND GUIDELINES

- Be sure Cam Pin is installed in the Bolt Group. If it is not, your firearm can still fire and **COULD MALFUNCTION, CAUSING PROPERTY DAMAGE, PERSONAL INJURY OR DEATH**
- Never use a blank firing adapter on the HM15 firearm
- If your firearm stops firing with a live round in the chamber of a hot barrel (a misfire). **REMOVE THE ROUND FAST!** However, if you cannot remove it immediately, remove magazine and wait 15 minutes with the firearm pointing in a safe direction! This way you won't be hurt by a possible round firing
- If your bolt fails to unlock, and you try to free it by tapping the buttstock on the ground while pulling on the charging handle, keep yourself clear of the muzzle and the Firearm pointed down range
- If there is water or other obstructions in the barrel, do not fire the firearm. Pull the charging handle to the rear to break the seal to ensure the water will run off from the chamber through the ejection port area and visually inspect to ensure no other obstructions are present

- If a noticeable difference in sound or recoil is experienced, STOP FIRING and inspect your rifle
- If a bullet is lodged and can be removed by pushing it out with a cleaning rod, clean any unburned powder grains from the bore, chamber, and mechanism before resuming shooting. If the bullet cannot be dislodged by firmly tapping it with a cleaning rod, take the weapon to a qualified gunsmith or armorer and have the obstruction removed
- NOTE: With the Bolt Carrier Assembly locked to the rear, or in its forward position, if the firearm is dropped or jarred with a loaded magazine in place, a live round could be chambered
- **NEVER DISCHARGE THE FIREARM with any liquid inside of the suppressor assembly.**
- **NEVER USE ANY NON-JACKETED FRANGIBLE, UTA OR PRE-FRAGMENTED AMMUNITION THROUGH ANY HM DEFENSE SUPPRESSED MODEL. FRAGMENTS MAY DAMAGE THE DEVICE, CAUSE A SAFETY HAZARD AND VOID THE PRODUCT WARRANTY. DO NOT FIRE “TRACER” AMMUNITION THAT CONTAINS PHOSPHOROUS PELLETS FOR ILLUMINATION. FAULTY PROJECTILES COULD CAUSE DAMAGE TO YOUR FIREARM/SILENCER.**

5. LOADING THE HM RIFLE OR PISTOL



WARNING: AMMUNITION OF THE CORRECT CALIBER MUST BE MATCHED WITH THE SAME CALIBER THAT THE FIREARM IS CHAMBERED IN.

HM Defense recommends only using commercially available, high-quality ammunition that is clean, dry, in good condition and of the appropriate caliber for your firearm. The use of remanufactured and/or hand-loaded ammunition is not recommended.



WARNING: FORCING DAMAGED OR INCORRECT CALIBER AMMUNITION IN THE CHARGER CAN DAMAGE YOUR FIREARM AND CAN RESULT IN DAMAGE, INJURY OR DEATH.

- Load the magazine one round at a time. Place each round on top of the follower, between magazine lips and push down and through until round rotates under feed lips. Never load more than the amount of rounds the magazine is designed to hold.
- As rounds are pushed down, slide them to the rear of the magazine.



- Insert loaded magazine well with bullet points facing forward until the magazine catch engages and positively retains magazine. Pull down on the magazine to ensure it is fully seated in the magazine well. Always use the appropriate magazine for the caliber of the platform and ensure that the magazine is clean and in good condition. Examine the ammunition, particularly on and around the primer. Look for dents, scratches, or other signs of damage. Never load damaged ammunition.



- Always point your firearm in a safe direction and do not touch the trigger
- Pull the bolt fully to the rear with the charging handle and lock the bolt to the rear with bolt catch located on the left side of the weapon.



- Push the charging handle forward until it locks in place.

- Place safety in “SAFE” position and visually check chamber and receiver area to ensure it is free of obstructions or foreign matter.



- With the muzzle pointed in a safe direction, press the top of the bolt release located on the left side of the lower receiver. The bolt will move forward with enough force to chamber a round from the magazine into the chamber.



YOUR FIREARM IS NOW LOADED WITH A ROUND IN THE CHAMBER AND THE HAMMER IS COCKED.

- Keep rifle pointed in safe direction and switch safety to SAFE position.



NEVER LEAVE YOUR FIREARM COCKED AND LOCKED (READY TO FIRE) WITH SELECTOR LEVER BEING SET TO SAFE AS THIS IS THE FIRE POSITION AND IS EXTREMELY DANGEROUS! FIREARMS CAN EASILY BE ACCIDENTALLY DISCHARGE CAUSING DAMAGE, INJURY AND DEATH.

6. UNLOADING THE HM RIFLE OR PISTOL



WARNING: ALWAYS UNLOAD YOUR FIREARM IMMEDIATELY AFTER USE AND PRIOR TO CLEANING AND STORAGE TO MINIMIZE THE RISK OF ACCIDENTAL DISCHARGE.



WARNING: ALWAYS READ AND UNDERSTAND SAFETY INSTRUCTIONS BEFORE UNLOADING YOUR FIREARM. KEEP YOUR FIREARM POINTING IN A SAFE DIRECTION. DO NOT TOUCH THE TRIGGER AND KEEP HANDS AWAY FROM THE EJECTION PORT.

1. Point firearm in a safe direction.
2. Set the safety selector lever to “Safe”. Note: If hammer is not cocked, safety cannot be rotated to “Safe”.



3. Remove the magazine by pushing in on the magazine catch button while pulling the magazine from the receiver.



4. Pull the charging handle fully to the rear and lock bolt to the rear by pressing on the lower portion of the bolt catch. If not done so already, place safety on "Safe". IF a round was in the chamber, it should have been ejected. If the last round was fired, the bolt carrier group should already be locked to the rear provided a magazine was in place.



5. Inspect chamber through the ejection port to make sure the chamber is empty.
6. When the magazine is removed and the chamber is empty, push the top portion of the bolt catch to allow the bolt carrier group to go forward. Close the dust cover.



7. Remove remaining live rounds in the magazine by sliding them forward and out.
8. Collect all live ammunition for safe storage and spent cases for disposal.

7. STORAGE AND TRANSPORTATION

Store your rifle, parts and silencers in a safe location where unintended users will not have access. Proper lubrication is important, not only for proper weapon functionality but also to prevent moisture and other contaminants from causing damage to your rifle.

Storage of a loaded weapon is inherently dangerous. Unintended users may gain access to a loaded firearm. As a responsible gun owner, you should evaluate your individual safety situation and make the responsible decision to store your firearms in a safe manner.

HM Defense and Technology recommends that your rifle be transported in a hard-shell case. State laws regarding the transportation of firearms differs and as a responsible gun owner, you should familiarize yourself with the laws of your state as well as any state you are traveling through.

California, Connecticut, Hawaii, Maryland, Massachusetts, New Jersey, New York, the City of Chicago, IL, Washington D.C. and other states and communities have bans on many of the characteristics of HM Defense rifles and silencers. It is the responsibility of the owner to be familiar with all federal, state, county and city laws and ordinances when residing in or traveling through such communities to ensure compliance with the law.

8. AMMUNITION

All HM Defense products are designed and built to specifications to shoot standard factory, commercially available NATO compliant ammunition. The specifications for standard, commercially available NATO compliant ammunition include harder primers to withstand the slight indentation from the firing pin when the bolt chambers a cartridge. The slight indentation is normal. The use of civilian ammunition with more sensitive primers or hand-loads with commercial primers and/or improperly seated primers increases the risk of primer detonation when the bolt slams forward, firing the firearm. Every shooter should use extreme caution when loading a firearm. All HM Defense rifles have military specification chambers. All 5.56mm NATO chamber will fire commercial .223 Rem ammunition that are manufactured to SAAMI specification (Spec 1 chamber). At this time, HM Defense also chambers in 300 Black Out and recommends using quality ammunition for this caliber.

Use only recently made, high quality, original, factory manufactured or factory remanufactured NATO compliant ammunition of the caliber for which your firearm is chambered. The proper caliber is permanently engraved on your firearm barrel. Never attempt to use ammunition of any other caliber. Old ammunition may deteriorate from age causing it to be dangerous. Do not use cartridges that are dirty, wet, corroded, bent, or damaged. Do not oil cartridges. Do not spray aerosol-type lubricants, preservatives, or cleaners directly onto cartridges or where excess spray may flow into contact with cartridges. Lubricant or other foreign matter on cartridges can cause potentially dangerous ammunition malfunctions. Always store ammunition in a cool, dry place to prevent contamination and/or deterioration of the primer and powder. Use only ammunition of the caliber for which your firearm is chambered and manufactured for use. Defective ammunition can create excessive pressures resulting in an explosion and cause injury or death to you and /or those nearby. **YOU MUST ASSUME RESPONSIBILTIY FOR USING PROPER AND SAFE AMMUNITION.** Keep ammunition separated by caliber at home and on the range. This can be done by keeping it in the original box. Throw ammunition away that has been dented or deformed, shows signs of wear such as split or cracked necks, cratered or flattened primers or punctured cases. If you have any reason to questions the safety of any cartridge, do not use it and safely discard it immediately. **DO NOT UNDER ANY CIRCUMSTANCES USE OLD OR RELOADED AMMUNITION PURCHASED AT GUN SHOWS, ESTATE SALES OR AUCTIONS.**



WARNING: DO NOT FIRE NON-JACKETED FRANGIBLE, UTA OR PRE-FRAGMENTED AMMUNITION THROUGH ANY HM DEFENSE SUPPRESSED MODEL. FRAGMENTS MAY DAMAGE THE DEVICE, CAUSE A SAFETY HAZARD AND VOID THE PRODUCT WARRANTY. DO NOT FIRE “TRACER” AMMUNITION THAT CONTAINS PHOSPHOROUS PELLETS FOR ILLUMINATION. FAULTY PROJECTILES COULD CAUSE DAMAGE TO YOUR FIREARM/SILENCER.

The use of reloaded, hand-loaded or other non-standard ammunition voids all warranties. Reloading is a science and improperly loaded ammunition can be extremely dangerous. Severe damage to the firearms and serious injury to the shooter or to others may result. Reloaded ammunition that may function in a bolt or slide action firearm may not properly function and may even explode in a semi-automatic weapon. The risk of a mishap is reduced by using current, clean ammunition that complies with the North Atlantic Treaty Organization (NATO) specifications.



FIREARMS MAY BE SEVERELY DAMAGED AND SERIOUS INJURY TO THE SHOOTER OR TO OTHERS MAY RESULT FROM ANY CONDITION CAUSING EXCESSIVE PRESSURE INSIDE THE CHAMBER OR BARREL DURING FIRING. EXCESSIVE PRESSURE CAN BE CAUSED BY OBSTRUCTIONS IN THE BARREL, PROPELLANT POWDER OVERLOADS, OR BY THE USE OF INCORRECT CARTRIDGES OR DEFECTIVELY ASSEMBLED CARTRIDGES. IN ADDITION, THE USE OF DIRTY, CORRODED, OR DAMAGED CARTRIDGES MAY CAUSE PERSONAL INJURY FROM THE SUDDEN ESCAPE OF HIGH-PRESSURE PROPELLANT GAS WITHIN THE FIREARM'S MECHANISM

Immediately stop shooting and check the barrel for an obstruction whenever:

- You have difficulty in, or feel unusual resistance in, chambering a cartridge
- A cartridge misfires (does not go off)
- The mechanism fails to extract a fired cartridge case
- Unburned grains of propellant powder are discovered spilled in the mechanism
- A shot sounds weak or abnormal. In such cases it is possible that a bullet is lodged part way down the barrel. Firing a subsequent bullet into the obstructed barrel can destroy the firearm and cause serious injury to the shooter and to bystanders.

Bullets can become lodged in the barrel:

- If the cartridge has been improperly loaded without propellant powder, or if the powder fails to ignite. (Ignition of the cartridge primer alone will push the bullet out of the cartridge case, but usually does not generate sufficient energy to expel the bullet completely from the barrel.)
- If the bullet is not properly seated tightly in the cartridge case. When such a cartridge is extracted from the chamber without being fired, the bullet may be left behind in the bore at the point where the rifling begins. Subsequent chambering of another cartridge may push the first bullet further into the bore.



IF THERE IS ANY REASON TO SUSPECT THAT A BULLET IS OBSTRUCTING THE BARREL, IMMEDIATELY UNLOAD THE FIREARM AND LOOK THROUGH THE BORE. IT IS NOT SUFFICIENT TO MERELY LOOK IN THE CHAMBER. A BULLET MAY BE LODGED SOME DISTANCE DOWN THE BARREL WHERE IT CANNOT EASILY BE SEEN. IF A BULLET IS IN THE BORE, DO NOT ATTEMPT TO SHOOT IT OUT BY USING ANOTHER CARTRIDGE, OR BY BLOWING IT OUT WITH A BLANK OR ONE FROM WHICH THE BULLET HAS BEEN REMOVED. SUCH TECHNIQUES CAN GENERATE EXCESSIVE PRESSURE, DESTROY THE FIREARM AND CAUSE SERIOUS PERSONAL INJURY TO YOU AND BYSTANDERS.

If the bullet can be removed by pushing it out with a cleaning rod, clean any unburned powder grains from the bore, chamber, and mechanism before resuming shooting. If the bullet cannot be dislodged by firmly tapping it with a cleaning rod, take the firearm to a gunsmith.

While shooting any semi-automatic firearm, an unfired cartridge or fired cartridge case may occasionally become jammed between the bolt and the barrel. Clear the jam as follows, **WHILE KEEPING THE MUZZLE POINTED IN A SAFE DIRECTION**: Remove the magazine, then pull back the bolt and hold or lock it to the rear. The jammed cartridge or case now can be removed by shaking it out or by picking it out with the fingers. When the bolt is jammed closed, rotate the safety to “SAFE”, and remove the magazine while pointing the gun in a safe direction. **Immediately take the weapon to a qualified gunsmith or armorer to determine what caused the jam before resuming shooting.**

Dirt, corrosion, or other foreign matter on a cartridge can impede complete chambering and may cause the cartridge case to burst upon firing. The same is true of cartridges which are damaged or deformed.

Do not oil cartridges and be sure to wipe the chamber clean of any oil or preservative before commencing to shoot. Oil interferes with the friction

between the cartridge case and chamber wall that is necessary for safe functioning and subjects the firearm to stress like that imposed by excessive pressure.

Use lubricants sparingly on the moving parts of your firearm. Avoid excessive spraying of any aerosol gun care product, especially where it may get on ammunition. All lubricants, especially aerosol spray lubricants, can penetrate cartridge primers and cause misfires.

Some highly penetrative lubricants can also migrate inside cartridge cases and cause deterioration of the propellant powder and firing the powder may not ignite. If only the primer ignites there is danger that the bullet may become lodged in the barrel.

Never fire any semi-automatic firearm with your finger, hand, face, or other part of your body over or adjacent to the ejection port, or in any position where you may be struck by the reciprocating movement of the operating bolt or carrier group. Both the ejection of empty cartridge cases and the movement of the operating carrier group are part of the normal operating cycle of semi-automatic firearms and pose no safety hazard to the shooter if the firearm is held in a normal grip and fired at arm length as intended by its design. All firearms require periodic maintenance and inspection which may reveal a need for adjustment or repair. Have your firearm checked by a competent gunsmith or armorer annually even if it seems to be working well since breakage, improper functioning, undue wear, or corrosion of some components may not be apparent from external examination. If you notice ANY mechanical malfunction, DO NOT continue to use the firearm. UNLOAD the firearm and take it to a competent gunsmith or armorer immediately. Similarly, if water, sand, or other foreign matter enters the internal mechanism, the firearm should be dismantled for complete and thorough cleaning. Failure to keep your firearm clean and in proper working order can lead to a potentially dangerous condition.



CAUTION: Never put your finger into the upper ejection port when the bolt is locked in the open position.

9. PREPARING TO FIRE



THE FAILURE TO FOLLOW FIREARM SAFETY REQUIREMENTS WILL CAUSE SERIOUS PERSONAL INJURY OR DEATH TO YOU OR OTHERS. ALWAYS TREAT ALL FIREARMS AS IF THEY WERE LOADED. ALWAYS BE SURE THAT THE ACTION OF FIREARMS ARE OPEN, THAT CHAMBERS ARE CLEAR OF CARTRIDGES, MAGAZINES ARE REMOVED, AND THAT FIREARMS ARE POINTING IN A SAFE DIRECTION.



ALWAYS WEAR ADEQUATE AND PROPER EAR PROTECTORS SPECIFIED FOR FIREARM USE TO PREVENT PERMANENT DAMAGE TO YOUR HEARING. Make sure others who are nearby are wearing ear protection as well.



ALWAYS WEAR SAFETY GLASSES SPECIFIED FOR FIREARMS USE, WHETHER INDOORS OR OUT. Safety glasses should protect your eyes from the firing flash and particles associated with the discharge of ammunition. Failure to do so creates a risk of personal injury from particle or debris spitting or ricochets.



ALWAYS BE ALERT AND ALWAYS FOLLOW THE SAFETY INSTRUCTIONS OF THE RANGE OFFICER. NEVER SHOOT IF YOU ARE TIRED, COLD, OR IMPAIRED IN ANY WAY.



ALWAYS BE AWARE OF OTHER PEOPLE AND MOVABLE OBJECTS IN YOUR SURROUNDING AREA SO THAT THEY DO NOT ACCIDENTALLY WALK INTO THE LINE OF FIRE.



THE SHOOTER (AND ALL OTHERS IN THE SHOOTING AREA) MUST ALWAYS BE IN A POSITION THAT IS OUT OF THE LINE OF FIRE AND ARE NOT WITHIN AN AREA WHERE THEY MAY BE STRUCK BY RICOCHETS, PARTICLE SPITTING FROM A FIREARM, OR BY EJECTED CASES FROM OTHER TYPES OF FIREARMS.



NEVER USE ALCOHOL OR DRUGS BEFORE OR WHILE SHOOTING.

10. FIRING YOUR HM RIFLE OR PISTOL

Warnings:

Before firing your firearm, practice your stance, sight alignment and breathing or a steady aim with your firearm unloaded. Practice firing your firearm at a range before using your firearm for any other type of shooting.



FIREARMS MAY BE SEVERELY DAMAGED AND SERIOUS INJURY TO THE SHOOTER OR OTHERS MAY RESULT FROM ANY CONDITION CAUSING EXCESSIVE PRESSURE INSIDE THE CHAMBER OR BARREL DURING FIRING. EXCESSIVE PRESSURE CAN BE CAUSED BY OBSTRUCTIONS IN THE BARREL, PROPELLANT POWDER OVERLOADS OR BY THE USE OF INCORRECT CARTRIDGES OR DEFECTIVELY ASSEMBLED CARTRIDGES. IN ADDITION, THE USE OF DIRTY, CORRODED OR DAMAGED CARTRIDGES MAY CAUSE PERSONAL INJURY FROM THE SUDDEN ESCAPE OF HIGH-PRESSURE PROPELLANT GAS WITHIN THE FIREARM'S MECHANISM.



READ AND UNDERSTAND SAFETY INSTRUCTIONS IN SECTION 3 OF THIS MANUAL. KEEP YOUR FIREARM POINTED IN A SAFE DIRECTION. DO NOT TOUCH THE TRIGGER AND KEEP YOUR HANDS AWAY FROM THE EJECTION PORT.



IF THERE IS ANY REASON TO SUSPECT THAT A BULLET IS OBSTRUCTING THE BARREL, IMMEDIATELY UNLOAD THE FIREARM AND LOOK THROUGH THE BORE. IT IS NOT SUFFICIENT TO MERELY LOOK IN THE CHAMBER. A BULLET MAY BE LODGED SOME DISTANCE DOWN THE BARREL WHERE IT CANNOT EASILY BE SEEN. IF A BULLET IS IN THE BORE, DO NOT ATTEMPT TO SHOOT IT OUT BY USING ANOTHER CARTRIDGE, OR BY BLOWING IT OUT WITH A BLANK OR ONE FROM WHICH THE BULLET HAS BEEN REMOVED. SUCH TECHNIQUES CAN GENERATE EXCESSIVE PRESSURE, DESTROY THE FIREARM AND CAUSE SERIOUS PERSONAL INJURY TO YOU AND BYSTANDERS.

Immediately stop shooting and check the barrel for an obstruction whenever:

- You have difficulty in, or feel unusual resistance in, chambering a cartridge
- A cartridge misfires (does not go off)
- The mechanism fails to extract a fired cartridge case
- Unburned grains of propellant powder are discovered spilled in the mechanism
- A shot sounds weak or abnormal. In such cases it is possible that a bullet is lodged part way down the barrel. Firing a subsequent bullet into the obstructed barrel can destroy the firearm and cause serious injury to the shooter and to bystanders.

Bullets can become lodged in the barrel:

- If the cartridge has been improperly loaded without propellant powder, or if the powder fails to ignite. (Ignition of the cartridge primer alone will push the bullet out of the cartridge case, but usually does not generate sufficient energy to expel the bullet completely from the barrel.)
- If the bullet is not properly seated tightly in the cartridge case. When such a cartridge is extracted from the chamber without being fired, the bullet may be left behind in the bore at the point where the rifling begins. Subsequent chambering of another cartridge may push the first bullet further into the bore.

If the bullet can be removed by pushing it out with a cleaning rod, clean any unburned powder grains from the bore, chamber, and mechanism before resuming shooting. If the bullet cannot be dislodged by firmly tapping it with a cleaning rod, take the firearm to a gunsmith.

While shooting any semi-automatic firearm, an unfired cartridge or fired cartridge case may occasionally become jammed between the bolt and the barrel. Clear the jam as follows, **WHILE KEEPING THE MUZZLE POINTED IN A SAFE DIRECTION**: Remove the magazine, then pull back the bolt and hold or lock it to the rear. The jammed cartridge or case now can be removed by shaking it out or by picking it out with the fingers. When the bolt is jammed closed, rotate the safety to “SAFE”, and remove the magazine while pointing the gun in a safe direction. **Immediately take the weapon to a qualified gunsmith or armorer to determine what caused the jam before resuming shooting.**

Dirt, corrosion, or other foreign matter on a cartridge can impede complete chambering and may cause the cartridge case to burst upon firing. The same is true of cartridges which are damaged or deformed.

Do not oil cartridges and be sure to wipe the chamber clean of any oil or preservative before commencing to shoot. Oil interferes with the friction between the cartridge case and chamber wall that is necessary for safe functioning and subjects the firearm to stress like that imposed by excessive pressure.

Use lubricants sparingly on the moving parts of your firearm. Avoid excessive spraying of any aerosol gun care product, especially where it may get on

ammunition. All lubricants, especially aerosol spray lubricants, can penetrate cartridge primers and cause misfires. Some highly penetrative lubricants can also migrate inside cartridge cases and cause deterioration of the propellant powder and firing the powder may not ignite. If only the primer ignites there is danger that the bullet may become lodged in the barrel.

Never fire any semi-automatic firearm with your finger, hand, face, or other part of your body over or adjacent to the ejection port, or in any position where you may be struck by the reciprocating movement of the operating bolt or carrier group. Both the ejection of empty cartridge cases and the movement of the operating carrier group are part of the normal operating cycle of semi-automatic firearms and pose no safety hazard to the shooter if the firearm is held in a normal grip and fired at arm length as intended by its design. All firearms require periodic maintenance and inspection which may reveal a need for adjustment or repair. Have your firearm checked by a competent gunsmith or armorer annually even if it seems to be working well since breakage, improper functioning, undue wear, or corrosion of some components may not be apparent from external examination. If you notice ANY mechanical malfunction, DO NOT continue to use the firearm. UNLOAD the firearm and take it to a competent gunsmith or armorer immediately. Similarly, if water, sand, or other foreign matter enters the internal mechanism, the firearm should be dismantled for complete and thorough cleaning. Failure to keep your firearm clean and in proper working order can lead to a potentially dangerous condition.

FIRING:

1. Load your firearm as previously described.
2. Grasp firearm with one hand on the handguard and the other on the pistol grip.



Warning: All HM Defense pistols are not designed to be shouldered. Shooting AR15 pistols from the shoulder can cause injury. All AR15 pistols are designed to be shot at arm's length with stabilizing braces to stabilize one-handed shooting.

3. Aim by aligning target with sights.
4. Move safety selector lever to “SEMI”
5. Maintaining steady aim, place index finger on trigger and squeeze straight back until the trigger releases the hammer firing the hammer. DO NOT jerk the trigger as you will disturb your aim and affect your accuracy. To fire the second and subsequent rounds, all that is necessary is to release the trigger and squeeze it again after every shot until you have completed firing or emptied the magazine.



WARNING: HM DEFENSE FIREARMS ARE SEMI-AUTOMATIC FIREARMS AND THEY ARE IMMEDIATELY LOADED AND READY TO FIRE AFTER EACH SHOT UNTIL THE MAGAZINE IS EMPTY! TO UNLOAD THE FIREARM, THE MAGAZINE MUST BE REMOVED AND THE BOLT CARRIER GROUP (BCG) MUST BE PULLED TO THE REAR WITH THE CHARGING HANDLE TO EXTRACT ANY REMAINING ROUND FROM THE CHAMBER.



WARNING: THE FIREARM CAN ALSO BE FIRED WITHOUT A MAGAZINE IN PLACE IF A ROUND IS LEFT IN THE CHAMBER.

6. After releasing the trigger, remove your finger from the trigger and set selector lever to “SAFE”. If the last round was fired from the magazine, the bolt will be held to the rear so that the firearm can quickly be reloaded by replacing with a loaded magazine or the chamber can be inspected to make sure it is empty.
7. Unload your firearm as described in section 5.



WARNING: NEVER LEAVE YOUR FIREARM COCKED AND READY TO FIRE WITHOUT SELECTOR LEVER SET TO “SAFE” AS THIS IS THE FIRE CONDITION AND IS EXTREMELY DANGEROUS. YOUR FIREARM CAN EASILY BE ACCIDENTALLY DISCHARGE, CAUSING DAMAGE, INJURY OR DEATH.



WARNING: IF FIRING A SUPPRESSED/SILENCER MODEL (STEALTH), SUPPRESSOR CAN BECOME VERY HOT. DO NOT TOUCH THE SUPPRESSOR OR ALLOW THE SUPPRESSOR TO TOUCH ANY FLAMMABLE ITEM OR ANY ITEM WHICH MIGHT MELT.

11. FIELD STRIPPING FOR CLEANING



WARNING: ALWAYS WEAR SAFETY GLASSES WHEN CLEANING OR MAINTAINING YOUR FIREARM.

1. Press in the rear takedown pin from the left-hand side of lower receiver and pull the pin out of the right-hand side of the receiver unit it comes to a stop.
2. Pivot the lower receiver in a downward motion away from the upper receiver.
3. Separate the upper receiver from the lower receiver by pressing the front takedown pin on the left-hand side of the receiver until it comes to a stop.
4. Pull the charging handle to the rear and remove the bolt carrier group.
5. Remove the charging handle by pulling it backward to the keyway and then down and out of the upper receiver.
6. Remove the cotter pin that retains the firing pin from the bolt carrier group by pulling it out.
Tilt the bolt face to allow the firing pin to be removed from the carrier.
7. Push the bolt inwards until the bolt comes to a stop. Next, turn the bolt cam pin 90 degrees until it can be removed from the carrier.
8. Pull the bolt and remove it from the carrier.
9. Removal of the handguard/rail is generally not necessary unless dirt has accumulated in or around the handguard. If removal is necessary, please take firearm to a gunsmith. Handguard removal/installation and torque specifications are available from HM Defense. To clean the handguard, use compressed air to remove dirt and debris. Lubricate as needed.
10. Remove the buttstock/brace from the lower receiver. Pull the latch tabs to completely remove the stock/brace from the buffer tube.
11. Depress the buffer while maintaining pressure on the buffer to prevent it from being ejected and depress the buffer retaining pin. Remove the buffer and buffer spring.



WARNING: DO NOT STRIP YOUR FIREARM FURTHER THAN PREVIOUSLY DESCRIBED. IF ADDITIONAL MAINTENANCE IS REQUIRED, PLEASE CONTACT HM DEFENSE OR A GUNSMITH.



WARNING: IF YOU ATTEMPT TO FIRE WITHOUT THE BOLT CAM PIN INSTALLED, DAMAGE TO YOUR FIREARM OR INJURY CAN RESULT.

12. CLEANING AND MAINTENANCE

12A. **FOR UNSUPPRESSED MODELS ONLY-NO STEALTH MODELS)**

SEE SECTION 12B. FOR CLEANING AND MAINTENANCE OF SUPPRESSED MODELS.

Properly maintaining your firearm is essential. Your firearm will last longer, perform better and remain safer with proper maintenance.



WARNING: BEFORE CLEANING OR MAINTENANCE, MAKE SURE YOUR FIREARM IS UNLOADED. (SEE SECTION “6. UNLOADING THE HM RIFLE OR PISTOL”) MAKE SURE YOUR MAGAZINE IS REMOVED AND THE CHAMBER IS EMPTY. ALWAYS FOLLOW THE RULES OF SAFE GUN HANDLING.



WARNING: CLEANING FIREARMS, DISCHARGING FIREARMS IN POORLY VENTILATED AREAS, OR HANDLING AMMUNITION MAY RESULT IN EXPOSURE TO LEAD AND OTHER HARMFUL SUBSTANCES WHICH ARE KNOWN TO THE STATE OF CALIFORNIA, ETC. TO CAUSE BIRTH DEFECTS, REPRODUCTIVE HARM AND OTHER SERIOUS PHYSICAL INJURY. HAVE ADEQUATE VENTILATION AT ALL TIMES. BE SURE TO ALWAYS WASH HANDS THOROUGHLY AFTER POSSIBLE EXPOSURE.



WARNING: ALWAYS ALLOW YOUR FIREARM TO COOL TO ROOM TEMPERATURE BEFORE BEGIN ANY CLEANING OR MAINTENANCE.



WARNING: ALWAYS WEAR SAFETY GLASSES WHEN CLEANING OR MAINTAINING YOUR FIREARM.

Before using your firearm for the first time, it should be cleaned. Your firearm has been treated with either a preservative or oil to protect against corrosion. Before using it, all excess oil should be wiped from the bore, chamber and exposed areas using a clean swab or patch. A light coat of high-quality gun oil should be applied to the outside surfaces and mechanism. Care should be taken not to oil the mechanism to the extent where oil will be dripping or running down the firearm. Dirt and residue will be trapped if too much oil is present.

Avoid contact between cleaning rod and muzzle as resultant wear will reduce accuracy.

Attach a cotton flannel patch to the end of a cleaning rod. Insert it in the chamber and pass rod and patch down through the barrel. Repeat, changing patches until the patch comes out clean.

Visually inspect the barrel. If it is clean, wipe all components dry and lubricate. If it is still dirty, continue with cleaning.

Attach brass wire bristle or nylon brush to cleaning rod and dip brush in gun cleaning solution. Thoroughly scrub out barrel, passing the brush all the way through before reversing the

movement. If you try to change direction with brush and barrel, the brush will stick.

Attach a larger, chamber cleaning brush to the cleaning rod, dip the brush in bore cleaning solution and clean the chamber. Use a minimum of five plunge strokes and three 360 degrees clockwise, rotational strokes.

WIPE ALL COMPONENTS CLEAN AND DRY.

Lightly moisten a flannel patch with gun oil and pass it once through the barrel, leaving a thin film of oil on the inside surface. Leave this film of oil on the inside surface if the firearm is to be stored. If it is not to be stored or if it is being removed from storage for use, pass a dry patch through barrel and chamber to remove as much oil as possible.

Remove any gun cleaning solution, oil and fingerprints from the outside surfaces of the firearm. (Finger moisture, if left, could start a corrosion process)

NOTICE: Gas tube will discolor from heat. Do not attempt to remove discoloration.

NOTICE: Always follow the instructions provided with your gun cleaner and gun lubricant.

Some cleaners can cause damage to your firearms. You should avoid prolonged solvent immersion and prolonged ultrasonic cleaning of your firearm. Choice of solvent should be restricted to those products specifically developed for firearms maintenance. Damage to a firearm's finish may occur if these cautions are ignored. Ammoniated solvents or other strong alkaline solvents should not be used on HM

Defense firearm. As a rule of thumb, if you would be comfortable applying the solvent of your choice to the finish of your automobile, it would probably be safe for use on your firearm.

After the cleaning, there may be some residue in both the barrel and action that works out and becomes apparent within 24-48 hours. This can be removed with a bristle brush and a light reapplication of powder removing solvent after which the oil film should be re-established on all surfaces.

Cleaning is essential to ensure the proper functioning of your firearm.

Your firearm is a precision instrument. To ensure reliable function it is necessary to follow a routine maintenance procedure. After firing your firearm, be sure to unload it following the procedure outlined in the section entitled “6.

UNLOADING THE HM RIFLE OR PISTOL” before performing any cleaning or maintenance procedure.



WARNING: NEVER MANIPULATE, ADJUST OR CHANGE ANY OF THE INTERNAL COMPONENTS OF YOUR FIREARM UNLESS SPECIFICALLY DIRECTED TO DO SO IN THIS MANUAL. IMPROPER MANIPULATION OF ANY INTERNAL COMPONENT MAY AFFECT THE SAFETY AND RELIABILITY OF YOUR FIREARM AND MAY CAUSE SERIOUS INJURY OR DEATH.



WARNING: ANY MAINTENANCE OR SERVICE NOT SPECIFIED IN THIS MANUAL MUST BE PERFORMED BY A QUALIFIED GUNSMITH USING GENUINE LEWIS MACHINE & TOOL CO. PARTS. IF YOU DO OTHERWISE, IMPROPER FUNCTIONING OF YOUR FIREARM MAY OCCUR AND SERIOUS INJURY OR DEATH MAY RESULT.

If your firearm will be used or stored in a cold climate, be sure to use an oil of appropriate weight so that it will not congeal in the cold temperatures.

12. CLEANING AND MAINTENANCE CONTINUED

12B. FOR SUPPRESSED MODELS ONLY-STEALTH SERIES

StealthMS Rifle Models StealthMS Complete Upper Models

Properly maintaining your firearm is essential. Your firearm will last longer, perform better and remain safer with proper maintenance.



IMPORTANT: DO NOT ATTEMPT TO REMOVE THE BARREL CAP ON THE SILENCER OF A SUPPRESSED HM DEFENSE PRODUCT. DOING SO WILL VOID THE WARRANTY.

REMOVAL OF THE BAFFLES IS NOT NECESSARY FOR CLEANING PURPOSES.



WARNING: BEFORE CLEANING OR MAINTENANCE, MAKE SURE YOUR FIREARM IS UNLOADED. (SEE SECTION “6.

UNLOADING THE HM RIFLE OR PISTOL”) MAKE SURE YOUR MAGAZINE IS REMOVED AND THE CHAMBER IS EMPTY. ALWAYS FOLLOW THE RULES OF SAFE GUN HANDLING.



WARNING: CLEANING FIREARMS, DISCHARGING FIREARMS IN POORLY VENTILATED AREAS, OR HANDLING AMMUNITION MAY RESULT IN EXPOSURE TO LEAD AND OTHER HARMFUL SUBSTANCES WHICH ARE KNOWN TO THE STATE OF CALIFORNIA, ETC. TO CAUSE BIRTH DEFECTS, REPRODUCTIVE HARM AND OTHER SERIOUS PHYSICAL INJURY. HAVE ADEQUATE VENTILATION AT ALL TIMES. BE SURE TO ALWAYS WASH HANDS THOROUGHLY AFTER POSSIBLE EXPOSURE.



WARNING: ALWAYS ALLOW YOUR FIREARM TO COOL TO ROOM TEMPERATURE BEFORE BEGIN ANY CLEANING OR MAINTENANCE.



WARNING: ALWAYS WEAR SAFETY GLASSES WHEN CLEANING OR MAINTAINING YOUR FIREARM.

Before using your firearm for the first time, it should be cleaned. Your firearm has been treated with either a preservative or oil to protect against corrosion. Before using it, all excess oil should be wiped from the bore, chamber and exposed areas using a clean swab or patch. A light coat of high-quality gun oil should be applied to the outside surfaces and mechanism. Care should be taken not to oil the mechanism to the extent where oil will be dripping or running down the firearm. Dirt and residue will be trapped if too much oil is present.

12B. CLEANING THE STEALTH SUPPRESSED MODELS



IMPORTANT: Failure to follow these instructions can be dangerous, can damage the silencer and will void the warranty.



WARNING! ENSURE BORE BRUSH AND MOPS ARE TIGHTLY SECURED TO THE CLEANING ROD SO THEY DO NOT COME LOOSE AND LODGE IN THE SUPPRESSOR CAVITY. IF A BORE BRUSH, BORE MOP OR ANY OBJECT BECOMES LODGED IN THE SUPPRESSOR CAVITY, DO NOT ATTEMPT TO SHOOT YOUR FIREARM. CONTACT HM DEFENSE CUSTOMER SERVICE AT 937-444-6500.



WARNING: DO NOT USE A CLEANING ROD AND PATCHES TO CLEAN THE INTEGRALLY SUPPRESSED MONOBLOC BARRELS (STEALTH). YOU MAY DAMAGE THE BAFFLE CORE OR LEAVE PATCHES IN THE SUPPRESSOR ASSEMBLY.

StealthMS5 models are integrally suppressed weapons that have a maintenance free silencer that does not require regular cleaning of the baffles and will function without degradation in sound reduction for many thousands of rounds.

Avoid contact between cleaning rod and muzzle as resultant wear will reduce accuracy.

5. The silencer cap is installed with Loctite so that it will not back off.
6. Do not try to remove the silencer cap or you can damage the barrel and silencer. If silencer service is required, it will be performed by an HM factory technician.
7. When cleaning the barrel, ALWAYS clean from the chamber end, NEVER from the muzzle end. Using a correctly sized, quality brass or nylon bore brush and solvent, insert the bore brush into the chamber and pass the rod and brush down through the barrel. Thoroughly scrub out barrel, passing the brush all the way through before reversing the movement. If you try to change direction with brush in the barrel, the brush will stick.
8. After cleaning the barrel using a bore brush, continue cleaning with a bore mop. Use a minimum of five plunge strokes and three 360 degrees clockwise,

12B. CLEANING THE STEALTH SUPPRESSED MODELS CONTINUED

9. rotational strokes. Do not use a jag and patch or the cleaning patch can fall into the silencer and removal will be difficult. Do not use a bore snake or it can get caught in the silencer baffles.
10. Do not fire the rifle or upper with any debris or liquids in the silencer. The bore and silencer must be clear of all debris prior to firing the weapon.
11. Suppressed firearms require frequent cleaning to remove carbon. Excess buildup of carbon can collect and effect functionality of your firearm if your firearm is not properly cleaned and maintained.

Remove any gun cleaning solution, oil and fingerprints from the outside surfaces of the firearm. (Finger moisture, if left, could start a corrosion process)

NOTICE: Gas tube will discolor from heat. Do not attempt to remove discoloration.

NOTICE: Always follow the instructions provided with your gun cleaner and gun lubricant.

Some cleaners can cause damage to your firearms. You should avoid prolonged solvent immersion and prolonged ultrasonic cleaning of your firearm. Choice of solvent should be restricted to those products specifically developed for firearms maintenance. Damage to a firearm's finish may occur if these cautions are ignored. Ammoniated solvents or other strong alkaline solvents should not be used on HM Defense firearm. As a rule of thumb, if you would be comfortable applying the solvent of your choice to the finish of your automobile, it would probably be safe for use on your firearm.

After the cleaning, there may be some residue in both the barrel and action that works out and becomes apparent within 24-48 hours. This can be removed with a bristle brush and a light reapplication of powder removing solvent after which the oil film should be re-established on all surfaces.

Cleaning is essential to ensure the proper functioning of your firearm.

12B. CLEANING THE STEALTH SUPPRESSED MODELS CONTINUED

Your firearm is a precision instrument. To ensure reliable function it is necessary to follow a routine maintenance procedure. After firing your firearm, be sure to unload it following the procedure outlined in the section entitled “6.

UNLOADING THE HM RIFLE OR PISTOL” before performing any cleaning or maintenance procedure.



WARNING: NEVER MANIPULATE, ADJUST OR CHANGE ANY OF THE INTERNAL COMPONENTS OF YOUR FIREARM UNLESS SPECIFICALLY DIRECTED TO DO SO IN THIS MANUAL. IMPROPER MANIPULATION OF ANY INTERNAL COMPONENT MAY AFFECT THE SAFETY AND RELIABILITY OF YOUR FIREARM AND MAY CAUSE SERIOUS INJURY OR DEATH.



WARNING: ANY MAINTENANCE OR SERVICE NOT SPECIFIED IN THIS MANUAL MUST BE PERFORMED BY A QUALIFIED GUNSMITH USING GENUINE LEWIS MACHINE & TOOL CO. PARTS. IF YOU DO OTHERWISE, IMPROPER FUNCTIONING OF YOUR FIREARM MAY OCCUR AND SERIOUS INJURY OR DEATH MAY RESULT.

If your firearm will be used or stored in a cold climate, be sure to use an oil of appropriate weight so that it will not congeal in the cold temperatures.

13. REASSEMBLY



WARNING: ALWAYS WEAR SAFETY GLASSES WHEN REASSEMBLING YOUR FIREARM.

1. Insert the buffer and buffer spring back into the buffer tube making sure the buffer is retained in place by the buffer retaining pin.
2. Pulling the latch tabs, insert the buttstock or brace on the buffer tube. Ensure that the buttstock/brace locks into place.
3. Insert the bolt back into the bolt carrier until it comes to a complete stop. Insert the cam pin into the cam pin socket and rotate 90 degrees for firing pin insertion.



WARNING: FAILURE TO REPLACE THE CAM PIN MAY CAUSE A DANGEROUS SITUATION DURING FIRING CAUSING PERSONAL INJURY OR DEATH.

4. Insert the firing pin through the rear of the carrier and ensure it is fully seated. Pull the bolt fully forward into the locked position.
5. Insert the cotter pin to retain the firing pin. Assure that the firing pin is retained in place. Verify that when the bolt is fully inserted into the carrier, push on the back side of the firing pin to verify that the pin is protruding out the bolt face.
6. Insert charging handle into the keyway of the upper receiver until it is retained into place.
7. Pull the charging handle out from the upper receiver and place the bolt carrier group (BCG) in the charging handle keyway. The bolt must be in the unlocked position to be able to insert it into the keyway. To unlock the bolt, pull the bolt face outward.
8. Push the charging handle and BCG completely into the upper receiver until a distinct click is heard.
9. In the lower receiver, push the hammer back into the cocked position. Once this is done, make sure the safety selector lever is in the “Safe” position.
10. Insert the upper receiver lugs into the lower receiver and push the front/pivot take down on the lower receiver through the lugs on the upper receiver. Drop the back of the upper into the lower receiver and push the back take down pin on the lower receiver through the lugs on the upper receiver.



WARNING: AFTER REASSEMBLY, FUNCTION TEST MUST BE PERFORMED. PROCEED TO FUNCTION TEST IN SECTION 14.

14. FUNCTION TEST

After stripping and reassembly of the weapon, the user must always carry out the function test to ensure that all operations will function properly. Tilt the weapon over to the left. Look into the ejection opening port ensuring the front face of the bolt and the chamber are clear from ammunition or obstructions.

Cock the weapon, rotate the fire selector lever to “Safe” and attempt to fire off the action. It must not fire.



Rotate the fire selector lever to “Fire”.

- Operate the trigger but do not release the trigger. The hammer should rotate forward about its axis under influence of its spring.



- Ensure the trigger is not released. Cock the weapon. The hammer should be retained to the rear by the disconnecter. Release the trigger. The hammer should be heard / felt to disengage from the disconnecter to be immediately retained by the sear.

15. ACTION OF MECHANISM

LOADING PROCEDURES AND FUNCTION BEFORE FIRING

The weapon is initially cocked, before firing, by pulling the charging handle completely to the rear, which will cause the bolt carrier group to move rearwards.

As the carrier moves rearward, it contacts the hammer, forcing it to rotate rearwards about its axis, cocking on the trigger.

- Empty magazine fitted. The magazine platform will actuate the bolt catch and hold the bolt carrier group to the rear.
- Loaded magazine fitted. The bolt catch must be operated manually by pressing on the lower projection of the bolt catch, to hold the bolt carrier group to the rear.
- No magazine fitted: The bolt catch must be operated manually by pressing on the lower projection of the bolt catch, to hold the bolt carrier group to the rear.

LOAD

With a loaded magazine on the weapon and the bolt carrier group to the rear, actuation of the bolt catch will allow the bolt carrier group to be driven forward under influence of the return spring. Do not soft close the bolt, release with full force.

As the carrier moves forward, the lugs of the bolt contact the base of the top round in the magazine and feed it into the chamber.

As the bolt locking lugs enter the barrel extension the round is stopped by the shoulder in the chamber. The ejector is pushed against the left side of the round base placing the ejector spring under tension. The extractor over-rides the round rim and snaps into the extractor groove on the right side of the round base.

LOCK

Forward motion of the bolt is stopped by the chamber. The bolt carrier continues to move forward until it is stopped by contact with the rear face of the barrel extension. At the same time, the bolt cam pin contacts the angled face of the

carrier cam slot, forcing the bolt to rotate. The bolt lugs rotate behind the barrel extension lugs, locking the bolt.

FIRE

With the fire selector lever set to “Fire” the weapon may be fired. When the trigger is squeezed, it rotates rearward about its axis, disengaging the sear from the hammer. The hammer then rotates forward under influence of its own spring. The front face of the hammer strikes the rear face of the firing pin, driving it forward impacting against the rear of the primer in the round. This ignites the propellant in the round, driving the projectile through the barrel.

UNLOCK

The projectile is forced through the barrel by the propellant gases. As the projectile passes the gas port some of the gases are bled off, passing along the gas tube, into bolt carrier key and then into the cylindrical section in the bolt carrier, where it fills the chamber behind the bolt.

The expansion of the gases begins to drive the bolt carrier rearwards.

During initial rearward movement of the bolt carrier, the bolt remains locked as the straight section of the bolt carrier cam slot moves un-obstructed over the bolt cam pin. This allows gas pressures in the bore to drop to a safe level before unlocking starts. (This is the dwell time.)

As the bolt carrier continues rearward, the angled face of the bolt carrier cam slot impinges on the bolt cam stud, forcing the bolt to rotate. This rotation of the bolt allows the lugs on the bolt to clear the lugs of the barrel extension. This allows unimpeded rearward movement, and as such unlocks the bolt from the barrel extension.

The bolt and bolt carrier continue to move rearward.

EXTRACTION

As the bolt moves rearward, the extractor which is pinned to the bolt and engaged in the cannular groove of the empty cartridge, withdraws the cartridge from the chamber.

EJECTION

The empty cartridge which is still held by the extractor is withdrawn from the chamber. As the cartridge clears the barrel extension and in line with the ejection port, the spring on the ejector re-asserts, forcing the base of the cartridge to rotate about the extractor. The force of the ejector spring re-asserting flicks the cartridge case out of the ejection port and clear of the weapon

NOTE: The ejection port cover assembly is opened by the bolt carrier acting on its latch housing, whenever the bolt is moved either forward or rearward.

CHARGING AFTER FIRING

As the carrier group continues rearward, it compresses the return spring and cocks the hammer:

- Repetitive: The hammer is rotated rearwards about its axis and compresses its spring. The disconnecter is rotated forward as a consequence of the trigger being pressed. As the hammer ends its rotation, the hook on the disconnecter engages the upper inside hook of the hammer, holding it to the rear. The bolt carrier group moves forward under influence of the return spring. When the trigger is released:
 - The trigger spring returns to its home position.
 1. The trigger rotates the disconnecter rearwards.
 2. The trigger sear, located on the front face of the trigger body, moves in front of the hammer.
 - The disconnecter hook disengages from the hammer as the disconnecter rotates rearwards. Unrestrained, the hammer rotates forward under influence of its spring, and the hammer hook engages with the hammer sear. The weapon is now ready to fire another shot.

16. TROUBLE SHOOTING

Shown in table 1. The trouble shooting guide does not cover all theoretical malfunctions. This also applies to suggested causes and corrective action. Qualified gunsmiths or armorers only must carry out repairs.

Problem	Common Cause	Corrective Action
Weapon fails to fire	Fire selector lever on "S"	Rotate lever to "F"
	Improper assembly of firing pin	Assemble correctly
	Excessive oil in firing pin hole	Clean
	Excessive carbon buildup on firing pin, or in firing pin hole	Clean
Bolt will not unlock	Burred bolt	Refer to Armorer
	Dirty bolt	Clean
Failure to extract	Broken extractor spring	Refer to Armorer
	Excessive carbon buildup in chamber	Clean
	Fouling or carbon in extractor recess	Clean
Failure to feed	Defective magazine	Replace
	Dirty magazine	Clean
	Movement of buffer is restricted	Strip and reassemble buffer and return spring
Round will not chamber	Excessive buildup of carbon in the chamber	Clean
	Damaged gas tube	Refer to Armorer
Bolt will not lock	Excessive buildup of carbon on the locking lugs	Clean
	Damaged locking lugs	Refer to Armorer
Failure to eject	Unserviceable ejector spring	Refer to Armorer
	Movement of the buffer is restricted	Strip and reassemble buffer and return spring
	Excessive carbon buildup in the interior of the gas key or on the exterior of the gas tube	Clean
	Soft closing bolt after pulling charging handle.	Release charging handle with full force.

17. WARRANTY & DISCLAIMER OF LIABILITY

WARRANTY

All HM firearms, parts and silencers are backed by our 100% parts and service warranty, applicable to all manufacturing defects. We guarantee your satisfaction with our products and services.

Upon receiving notice from the initial purchaser, HM Defense shall have the option of repairing or replacing any part claimed or found to be defective. This warranty does not cover any condition determined by HM Defense to be caused by or arising out of unauthorized repairs or modifications, negligent or careless use, normal wear and tear, abuse, failure to properly store or maintain the product, disassembly beyond the FIELD STRIPPING instructions in this manual, use of defective or improper ammunition, corrosion, or neglect. This warranty is exclusive and is in lieu of all or any other warranties written or oral, expressed, or implied.

To initiate a warranty claim, first fill out your warranty card or warranty information online when you receive your firearm/suppressor. Next call HM Defense at 937-444-6500 to discuss any issues and shipment of the firearm/silencer. Once shipment is arranged, customer will mail firearm to HM Defense along with a written description of the difficulty and proof of purchase.

HM DEFENSE MAKES NO WARRANTY OF MERCHANTABILITY OR FITNESS FOR PARTICULAR PURPOSE. HM DEFENSE SHALL HAVE NO LIABILITY FOR INCIDENTAL OR CONSEQUENTIAL DAMAGES.

DISCLAIMER OF LIABILITY

HM Defense disclaims any liability for personal injury, property damage or economic loss caused in whole or in part by handloaded, reloaded, remanufactured or defective ammunition. Under no circumstances will HM Defense be liable for personal injury, property damage or economic loss resulting from unsafe handling of the firearm/silencer, illegal use of the firearm/suppressor or unauthorized modifications to the firearm/silencer.